

Advantage III

Hybrid Series by Ebtron

Installation, Operation and Maintenance Technical Manual

HTx104

“Plug & Play” Transmitters

Includes Analog Output Model HTA104 and
RS-485 Output Model HTN104

Document Name: TM_HTx104_R6A1



TM_HTx104_R6A1



Part Number: 930-0150

LIST OF EFFECTIVE AND CHANGED PAGES

Insert latest changed pages (in bold text); remove and dispose of superseded pages.
 Total number of pages in this manual is **32**.

| Page No | Revision * | Description of Change | Date |
|---|------------|---|--------------------|
| 1 - 32 | R6A | Revised extensively to reflect updated firmware and features. | .05/09/2016 |
| 1, 2 | R5C | Updated title page and List of Effective Pages revision to R5C | .08/27/2013 |
| 7 | R5C | Corrected dimensions for case height | .08/27/2013 |
| 3-5, 9, 10, 17, 19, 20-22, 27, 28, 33, 35 | R5B | Updated to include HU1 (-U) Universal Probes | .02/22/2012 |
| 5, 11, 19, 22, 24 | R5A | Firmware update: Added HTN network alarm features/applicability and descriptions | .08/15/2012 |
| 19, 22, 24, 26 | R5A | Firmware update: Added altitude compensation features/details | .08/15/2012 |
| 15 | R5A | Added parity submenu items | .08/15/2012 |
| 21, 25 | R5A | Firmware update: Added AR1 submenu visibility when OUT1 U/M=CFM is selected | .08/15/2012 |
| 23 | R5A | Firmware update: Replaced Kv factor with AR1 submenu | .08/15/2012 |
| All other pages | R5A | Re-issued document as R5A | .08/15/2012 |
| 15 | R4J | Added MODBUS Parity submenu | .12/22/2011 |
| 16 | R4J | Modified MODBUS default communications note | .12/22/2011 |
| 22, 24, 26 | R4J | Modified INT TIM and ALRM DEL max range to 900 seconds | .12/22/2011 |
| 16 | R4H | Added note in Table 6 for MODBUS communications (8/1/None) | .09/23/2011 |
| 11 | R4G | Added note for Output Full Scale FS1 value and Setup Menu | .06/22/2011 |
| 30 | R4G | Modified "quantity of samples" text for product consistency | .06/22/2011 |
| 30 | R4F | Typo error on Field Cal Wiz - 200 samples changed to 1200 | .03/30/2011 |
| 35 | R4F | Revised wiring diagram to indicate alarm option connections | .03/30/2011 |
| 5 | R4E | Added in resolution for 0-5/0-10VDC analog outputs | .12/02/2010 |
| 31, 32 | R4D | Added MANUAL ADJUSTMENT OF FACTORY OFFSET/ GAIN CALIBRATION | .08/03/2010 |
| 33-36 | R4D | Repaginated for addition of pages 31 and 32 | .08/03/2010 |
| 9 | R4C | Added HE1 EX and OA probe connection details | .06/21/2010 |
| 5 | R4B | Modified Specifications to clarify HT1 Sensor Configuration | .06/01/2010 |
| 5, 6, 11, 19, 21 through 26 | R4A | Updated to include Advantage II firmware features | .02/08/2010 |
| 15 | R4A | Corrected COMM Menu entry method | .02/08/2010 |
| 16 | R4A | Added Modbus baud rate notes | .02/08/2010 |
| 33 | R4A | Added Appendices A and B HTA104, HTN104 Wiring Diagrams | .02/08/2010 |
| 30 | R3F | Added notes for clarification in Field Calibration Wizard menu | .11/08/2009 |
| 12 | R3E | Correction to Analog Conversion Table for Unidir'l Airflow (LPS) | .04/15/2009 |
| 21, 23, 25 | R3D | Update menu item order for firmware 1.08 revision | .03/31/2009 |
| 3-5, 7-9, 11, 14-30 | R3C | Republished as revision R3C | .02/18/2009 |
| 6 | R3C | Added status LED and legend | .02/18/2009 |
| 10 | R3C | Added status LED and legend | .02/18/2009 |
| 12 | R3C | Added K factor reference data to Table 3 | .02/18/2009 |
| 13 | R3C | Added status LEDs and legends | .02/18/2009 |
| 31, 32 | R3C | Revise <u>OUT1 (or 2)=0-5V ↓</u> table <u>OUT1 (or 2)=0-5V ↓</u> nomenclature | .02/18/2009 |
| 21 through 25 | R3B | Revised all 0-5V menu options from to | .11/21/2008 |
| 28 | R3B | Revised AREA STATUS/AREA MATCH menu option | .11/21/2008 |
| 1 through 32 | R3A | Revised extensively to include hardware/firmware changes resulting from 0-5V menu options and expanded RS-485 network connection information. | .11/17/2008 |

Copyright © 2010, EBTRON®, Inc.
 All brand names, trademarks and registered trademarks are the property of their respective owners. Information contained within this document is subject to change without notice. Visit EBTRON.com to view and/or download the most recent versions of this and other documents.
 All rights reserved.

TM HTx104_R6A

Table of Contents

| | |
|--|-----------|
| 1. OVERVIEW | 5 |
| 1.1 Specifications | 5 |
| 1.3 ORDERING GUIDE FOR HTx104 TRANSMITTER | 6 |
| 2. HTx104 TRANSMITTER INSTALLATION | 7 |
| 2.1 Mechanical Dimensions | 7 |
| 2.2 Power Transformer Selection | 8 |
| 2.3 Connecting Power to the Transmitter | 8 |
| 2.4 Connecting Sensor Probes to the Transmitter | 9 |
| 2.5 HTA104 Analog Output Transmitter Wiring and Set Up | 10 |
| 2.5.1 HTA104 Analog Output Wiring | 10 |
| 2.6 HTN104 RS-485 Network Output Transmitter Wiring and Set Up | 11 |
| 2.6.1 Network Cable Specifications | 11 |
| 2.6.2 HTN104 RS-485 Network Output Wiring | 11 |
| 2.6.3 HTN104 - Connecting to an RS-485 Network: | 12 |
| 2.6.4 HTN104 - Transmitter Setup for RS-485 Network Operation | 12 |
| 2.6.5 HTN104 - RS-485 Network Options and Communications Menu Settings | 12 |
| 2.6.6 HTN104 - Setting Transmitter Termination for RS-485 Network | 12 |
| 2.6.7 HTN104 - Setting RS-485 Network Protocol | 12 |
| 2.6.8 HTN104 - Setting Transmitter Address | 12 |
| 2.6.9 HTN104 - Setting Baud Rate | 12 |
| 2.6.10 HTN104 - Setting Modbus Parity | 12 |
| 2.6.11 HTN104 - Setting Device Instance Number | 12 |
| 2.6.12 HTN104 - Resetting Communications Options to Factory Default Values | 12 |
| 2.6.13 HTN104 BACnet Objects | 13 |
| 2.6.14 HTN104 Modbus Register Map | 13 |
| 3. HTx104 TRANSMITTER START UP | 14 |
| 3.1 Changing the System of Units - IP or SI Units | 14 |
| 3.2 HTx104 Transmitter Calibration | 14 |
| 3.3 HTx104 LCD Display Notifications | 14 |
| 3.3.1 LCD Display when using Dual Mode with Two Universal Probes | 14 |
| 3.4 Factory Default Menu Settings | 15 |
| 3.5 Changing Factory Default Setup Menu Settings | 15 |
| 3.5.1 Setup Menu Options | 15 |
| 3.5.2 Selecting Actual and Standard Output Measurement Type | 15 |
| 3.5.3 Output Scaling | 16 |
| 3.5.4 Changing the LCD Display from Volumetric Flow CFM to Velocity FPM | 16 |
| 3.5.5 HTA104 Converting the Analog Output Signal from FPM to CFM | 16 |
| 3.5.6 Locking the Configuration Settings | 16 |
| 3.6 HTx104 - Alarm Features | 17 |
| 3.6.1 No Fault (NO FAULT=HI) | 17 |
| 3.6.2 Alarm Indications | 17 |
| 3.6.3 Low Alarm - "LO ALRM= ON" | 17 |
| 3.6.4 High Alarm - "HI ALRM= ON" | 17 |
| 3.6.5 Trouble Alarm - "AO2 ASGN=TRBL" | 17 |
| 3.6.6 Zero Off Setting - "ZERO OFF=NO" | 18 |
| 3.7 Viewing Sensor Data | 18 |
| 3.7.1 Local Sensor Data Display | 18 |
| 3.7.2 Viewing Sensor Data over RS-485 BACnet and Modbus Networks | 18 |
| 4. FIELD ADJUSTMENTS | 18 |
| 4.1 Altitude Correction Adjustment | 18 |
| 4.2 Adjusting the Low Limit Cutoff | 18 |
| 4.3 Factory Calibration Adjustments | 18 |
| 4.4 Automated Field Adjustment using the Field Adjust Wizard | 19 |
| 4.4.1 Overview of the Field Adjustment Wizard | 19 |
| 4.4.2 Engaging and Using the Field Adjustment Wizard | 19 |
| 4.5 Manual Adjustment of Factory Offset/Gain Calibration | 19 |
| 4.5.1 Procedure for 1 Point Field Adjustment | 19 |
| 4.5.2 Procedure for 2 Point Field Adjustment | 19 |
| 5. STANDARD LIMITED PARTS WARRANTY | 20 |
| 6. MAINTENANCE | 20 |
| 6.1 General Troubleshooting (All HTx104 Systems) | 21 |
| 6.2 HTA104 - Analog Transmitter Troubleshooting | 22 |
| 6.3 HTN104 - RS485 Transmitter Troubleshooting | 22 |

(continued)

Table of Contents
(continued)

APPENDIX A - HTx104 SETUP MENUS23
 HTx104 System of Units Menu24
 HTx104 Universal Probe Setup Wizard24
 HTx104 Fan Sensor Setup Wizard24
 HTx104 Setup Menu Options25
APPENDIX B - HTx104 WIRING DIAGRAMS30
 HTA104 Wiring Diagram31
 HTA104 Wiring Diagram32

List of Figures

Figure 1. HTx104 Transmitter5
 Figure 2. HTx104 Transmitter Ordering Guide6
 Figure 3. HTx104 Transmitter Mechanical Detail Drawing7
 Figure 4. HTx104 Power Connections8
 Figure 5. Type A, Type B and Type C Transmitters9
 Figure 6. Connector Detail9
 Figure 7. HTA104 Analog Circuit Board Detail10
 Figure 8. HTN104 RS-485 Transmitter Circuit Board Detail11

List of Tables

Table 1. HTx104 Connectivity Options6
 Table 2. HTx104 Power Transformer Selection Guide8
 Table 3. HTN104 BACnet Object Lists13
 Table 4. HTN104 Modbus Register Maps13
 Table 5. Standard “IP” and “SI” Menu System of Units Abbreviations14
 Table 6. Factory Default Menu Settings15
 Table 7. HTA104 Analog Output Conversions16
 Table 8. HTA104 Alarm Types and Notifications17
 Table 9. General Troubleshooting (All HTx104 Systems)21
 Table 10. HTA104 Analog Transmitter Troubleshooting22
 Table 11. HTN104 RS-485 Transmitter Troubleshooting22

1. OVERVIEW

EBTRON's HTx104 (A3) transmitter is designed for measurement of airflow and temperature in duct, plenum and fan inlet applications. The HTx104 (A3) transmitter accepts from one to four probes with a total of up to 4 sensors and provides individual flow and temperature readings as well as average readings. A programmable alarm feature can be set for average flow low limit, high limit and system/probe/sensor faults. Analog output 2 (OUT2) can be configured as active low (OVDC / 4 mA) or active high (5/10VDC / 20 mA) when assigned as an alarm output. The transmitter is fully independent of the sensors and does not require field matching to them. It includes a 16 character LCD display for airflow, temperature, system configuration and diagnostics. Field configuration is accomplished through a simple four-button interface on the main circuit board. Individual sensor airflow and temperature measurements can be displayed from the diagnostic mode and are beneficial as an HVAC system diagnostic tool. The airflow output signal can be filtered, and a process low limit can be set to force the output to zero when airflow falls below a user defined value. A Field Adjustment Wizard feature can be engaged for one or two point field adjustment in applications where field adjustment is required. The HTx104 (A3) transmitter is available as analog output model HTA104 and network output model HTN104.

1.1 Specifications

Maximum Sensing Points

- 4 (4 Airflow + 4 Temperature, independently processed)

Sensor System Configurations (max.)

- Type A (probes x sensors/probe): 1 x 4
- Type B (probes x sensors/probe): 2 x 2
- Type C (probes x sensors/probe): 4 x 1

Digital Signal Processing

- Microprocessor: Yes
- Multiplexing: 8 individual channels
- A/D Converter: 12-Bit

"Plug and Play" Sensor Systems

- Probes do not require matching to transmitter

Power Requirements

- Voltage: 24 VAC (22.8 to 26.4 VAC), at 6 to 11 VA (dependent on number of sensors); isolation not required
- Brownout protection: "Watchdog" reset circuit
- Protection: Over voltage, over current and surge protection

Enclosure

- Aluminum

User Interface

- Pushbutton and LCD display

Display

- 16 character alpha-numeric auto-range

Output to Host Controls

- Output/Protocols Supported:

Model HTA104:

Isolated 0-5/0-10VDC or 4-20mA
(resolution 0-10VDC: 0.010% FS;
0-5VDC: 0.020% of FS)

Model HTN104: RS-485 Protocols:
BACnet MS/TP or Modbus RTU

Airflow Output Adjustments:

- Field Adjustment Wizard
- Offset/gain
- Airflow Output Signal Filter with adjustable integration
- Airflow Low Limit Cutoff: Forces output to zero below defined value
- Alarm Output features assign AO2 Output as low limit and high limit alarm with tolerance or as transmitter/sensor trouble alarm

System Diagnostics

- Sensor/transmitter diagnostic mode with notification

Environmental Limits

- Operating Temperature: -20° to 120° F (-28.8° to 48.8° C)
- Moisture: 0 to 99% RH, noncondensing (protect from water)

Compatible Sensor Systems

- HP1 probes, HF1 fan inlet sensors, HT1 small duct and HU1 Universal probes

Listings

- UL 873 Airflow & Temperature Indicating Devices
- CE (EU shipments only)

Warranty

- 36 months from shipment



Figure 1. HTx104 Transmitter

ADVANCED TECHNOLOGY

- Microprocessor-based electronics with industrial grade integrated circuits.
- "Plug and Play" sensor probe design.
- Accepts up to 4 individual airflow and temperature sensor pairs.
- LCD display.
- Pushbutton user interface for simple field configuration, diagnostics and Field Adjustment Wizard.
- Independent airflow and temperature outputs.
- Programmable alarm output for average flow low/high limits or system/sensor faults.
- Model HTA104: Analog Output
- Model HTN104: RS-485 Network output - BACnet MS/TP Master or Modbus RTU.

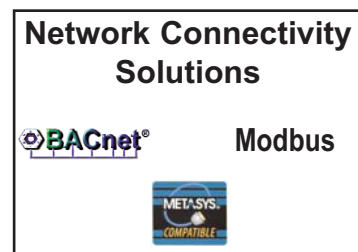

1.3 ORDERING GUIDE FOR HTx104 TRANSMITTER

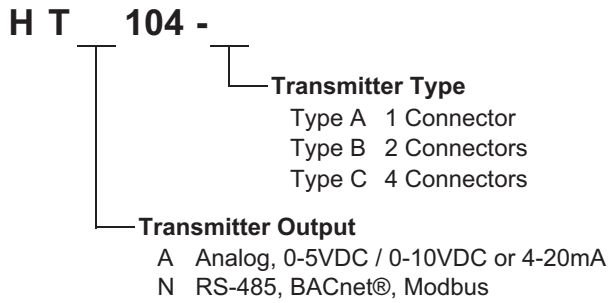

Figure 2. HTx104 Transmitter Ordering Guide

Table 1. HTx104 Connectivity Options

| Output to Host Controls | Output/Protocols Supported | Airflow | Temperature | Status |
|-------------------------|--|---------|-------------|--------|
| Analog x=A | Linear 0-5VDC ¹ / 0-10VDC or 4-20mA | Yes | Yes | Yes |
| RS-485 x=N | BACnet®-MS/TP, BACnet® | Yes | Yes | Yes |
| | Modbus-RTU | | | |

¹ 0-5 VDC analog output option introduced in firmware versions from 1.07 and later.

2. HTx104 TRANSMITTER INSTALLATION

The HTx104 transmitter is designed for use in an environment between -20° F to 120° F (-28.8° C to 48.8° C) where it will not be exposed to rain or snow. Install transmitter upright and in a field accessible location. The enclosure accepts 1/2 in. (12.7 mm) electrical fittings for signal and power wiring at both sides at the top of the enclosure.

Locate the transmitter so that the connecting cables from all of the sensor probes will reach the receptacles on the bottom of the transmitter enclosure.



In locations exposed to direct rain and/or snow, the transmitter must be enclosed in a NEMA4 enclosure.



Leave unobstructed space of at least 7.5 in. (190.5 mm) above, 2 in. (50.8 mm) to each side and 3.5 in. (88.9 mm) below the transmitter to allow for cover removal, probe connections and heat dissipation.



Locate the transmitter in a location that can be reached by all connecting cables from the sensor probes.



Do not drill into the transmitter enclosure since metal shavings could damage the electronics.

2.1 Mechanical Dimensions

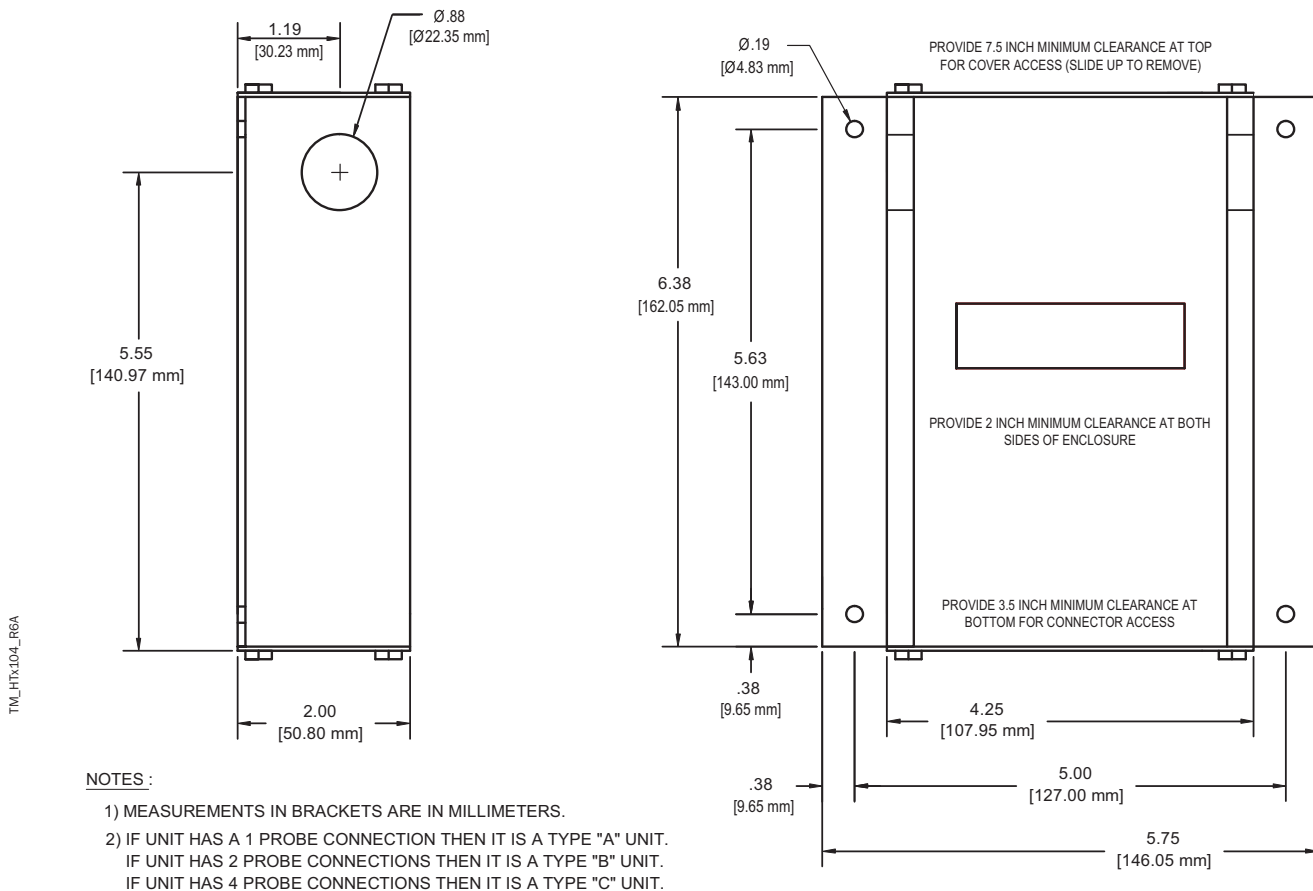

Figure 3. HTx104 Transmitter Mechanical Detail Drawing

2.2 Power Transformer Selection

Select a 24 VAC transformer based on the maximum power requirements of the transmitter label (11 VA) or from the values of Table 2. The operating supply voltage (transmitter power “ON” with all sensor probes connected) should not be less than 22.8 VAC or greater than 26.4 VAC.

Table 2. HTx104 Power Transformer Selection Guide

| | | | | |
|-----------------|---|---|---|----|
| Total Sensors | 1 | 2 | 3 | 4 |
| Minimum VA Req. | 6 | 8 | 9 | 11 |

2.3 Connecting Power to the Transmitter

Slide the cover plate up and off of the transmitter enclosure, and ensure that the power switch is in the “OFF” position before connecting 24 VAC power source wiring.

Connect 24 VAC power to the large, two position power input terminal labeled “POWER” on the upper right hand side of the main circuit board (Figure 4). Since the output signals are isolated from the power supply, it is not necessary to provide an isolated (secondary not grounded) power source.

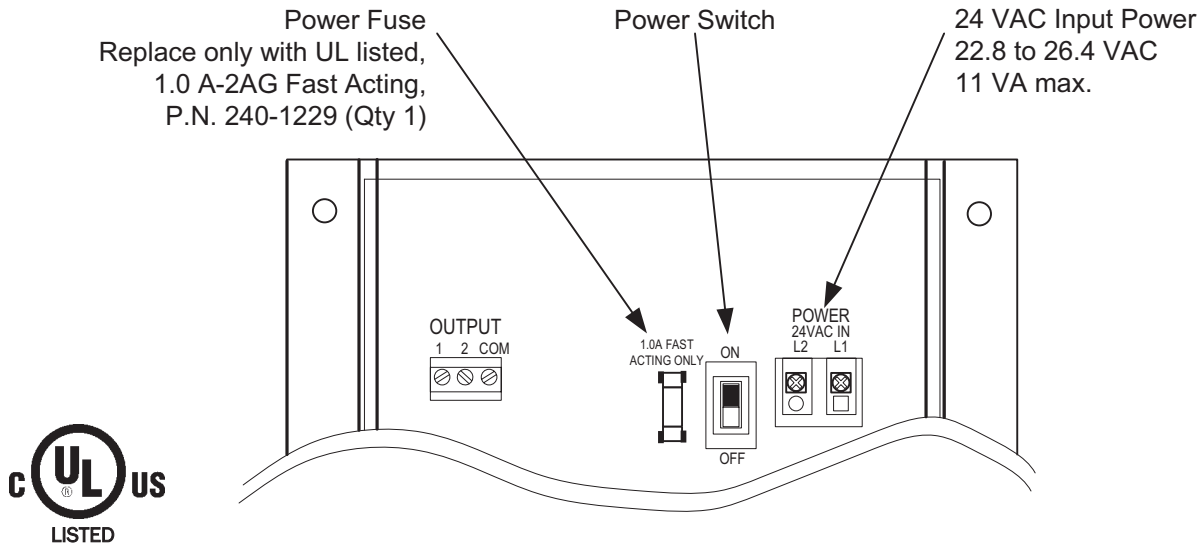

Figure 4. HTx104 Power Connections



Multiple HTx104 transmitters wired to a single transformer must be wired “in-phase” (L1 to L1, L2 to L2).





Sensor probes must be connected to the transmitter before turning the power switch to the “on” position to properly “flash” sensor calibration data to the transmitter.

TM HTx104_R6A

2.4 Connecting Sensor Probes to the Transmitter

After mounting the sensor probes and transmitter, connect the sensor probe cable plugs to the circular receptacles located at the bottom of the HTx104 transmitter enclosure. Probes are "Plug and Play" and do not have to be connected to a specific receptacle on the transmitter, unless HU1 probes and DUAL mode are engaged. Then, Probe 1 is in the left connector and Probe 2 is in the right connector. Transmitters accept HP1, HF1, HB1, HT1 or HU1 sensors. Mixing sensor types on transmitter is not permitted. Match probes to transmitter by type (A, B or C) as indicated on transmitter and probe tags, and as shown in Figure 5.

-  Provide a "drip loop" at the transmitter if there will be the potential for water runoff or condensation along the sensor probe cable(s).
-  Sensor probe cable plugs are "keyed" as shown in Figure 6. Line up plug with receptacle and push straight in to receptacle. **DO NOT TWIST.** Forcing the cable plug in or out of the receptacle will damage the connectors and void warranty.
-  When traverse data is desired, probes should be installed and connected to the transmitter using the mounting convention specified in the separate sensor probe Installation Guide. Proper installation simplifies sensor location decoding during data analysis.

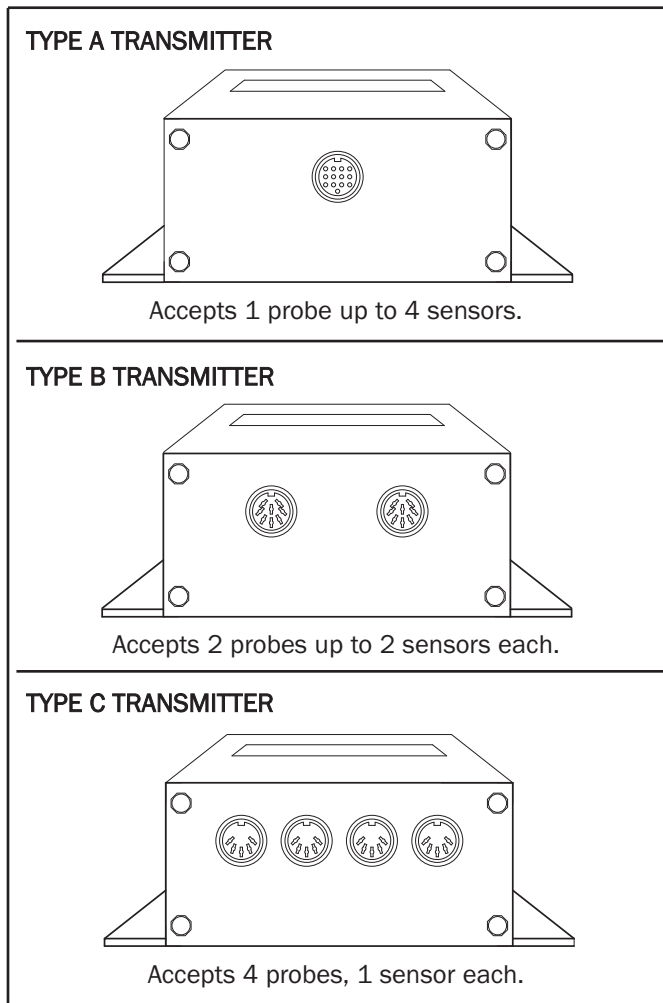

TM_HTx104_R6A

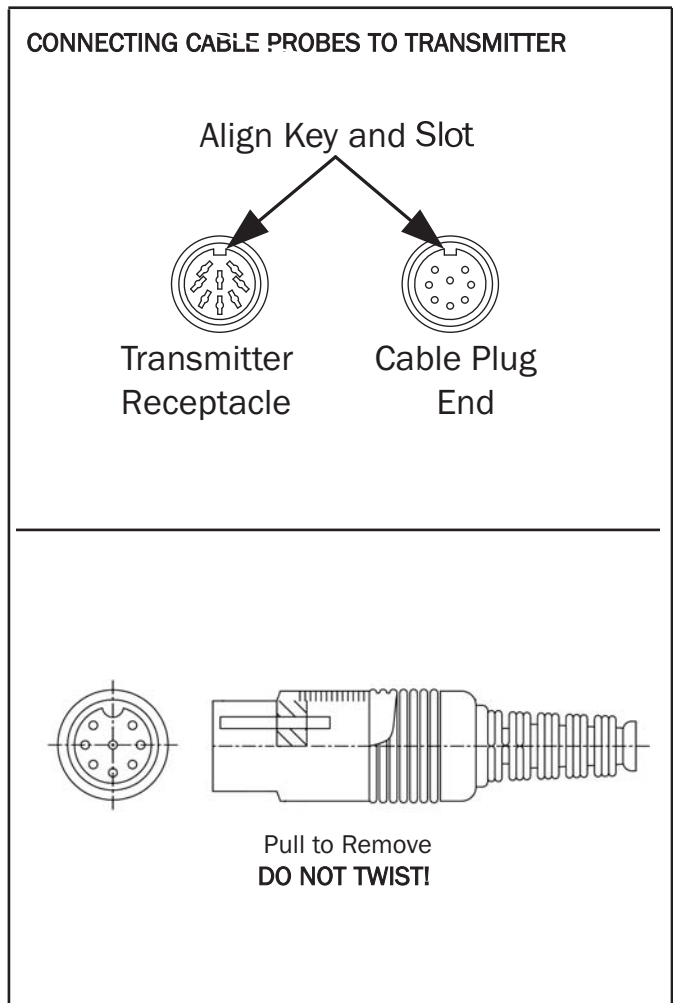

Figure 5. Type A, Type B and Type C Transmitters

Figure 6. Connector Detail

2.5 HTA104 Analog Output Transmitter Wiring and Set Up

Analog output connections are made at the top left of the transmitter main circuit board OUTPUT connector as shown in Figure 8. Independent 12-bit (4096 discrete states) linear analog outputs are provided for airflow at OUTPUT terminal 1, and for temperature (or alarm) at OUTPUT terminal 2, each with over voltage and over current protection. **Airflow and temperature outputs are field selectable for either 0-5/0-10VDC or 4-20 mA using Output 1/2 jumpers and Setup Menu.** The OUTPUT at terminal 2 can be assigned as a Low Limit or High Limit Alarm to provide an active high, active low or transmitter trouble alarm output. Outputs are galvanically isolated from the main power supply to permit simple integration with virtually all building automation systems.

2.5.1 HTA104 Analog Output Wiring

To prevent undesirable interference from other sources, **EBTRON** recommends the use of good quality shielded cabling. Appendix A of this document details HTA104 Analog Wiring. To wire the output signal, slide the cover plate up and off of the enclosure. Ensure that the power switch is in the "OFF" position. Connect signal wires for each analog output at the three position output terminal block labeled "OUTPUT" as indicated in Figure 7 and as shown in the wiring diagram of Appendix A. OUTPUT 1 is at terminal 1; OUTPUT 2 is at terminal 2; and the common connection is at the COM terminal.



***CAUTION**

When configured for 4-20 mA output, the HTA104 is a "4-wire" device. The host controls must not provide any excitation voltage to the output of the HTA104.

NOTE:

The transmitter is shipped from the factory with the analog output set for 4-20 mA. If 0-5 VDC or 0-10VDC output is desired, move the corresponding output jumper (OUT1 and/or OUT2) to the 0-10VDC position (see Figure 7), and set the "AO1 Range" and/or "AO2 Range" options in the SETUP MENU for 5VDC or 10VDC as shown in Figures 14 through 16.

If OUT1 or OUT2 jumpers for 4-20 mA or 0-5/0-10 VDC are changed, the SETUP menus for analog outputs A01 and A02 **MUST also be changed** to agree with the selected mode. Refer to SETUP menus, Figures 14 through 16.

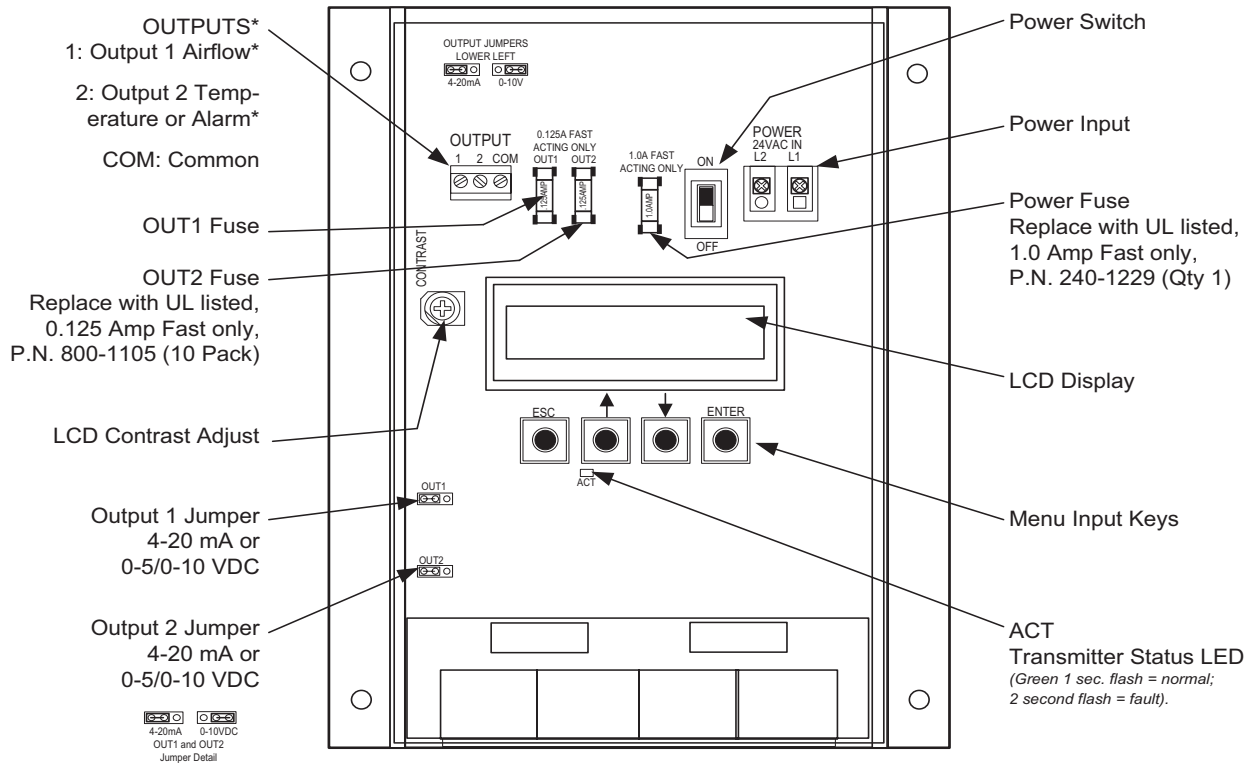

*Output 1 is Probe 1 Airflow when used with -U probes in DUAL mode
*Output 2 is Probe 2 Airflow when used with -U probes in DUAL mode

Figure 7. HTA104 Analog Circuit Board Detail

2.6 HTN104 RS-485 Network Output Transmitter Wiring and Set Up

The HTN104 (Figure 8) features field selectable firmware menu options for address and protocol selection, and a termination DIP switch for line termination selection to integrate with various network topologies.

2.6.1 Network Cable Specifications

The RS-485 network cable shall be shielded twisted pair with a characteristic impedance of 100 to 130 ohms. Distributed capacitance between conductors shall be less than 100 pF per meter. Distributed capacitance between conductors and shield shall be less than 200 pF per meter. The maximum recommended length of a network segment is 1200 meters with AWG 18 cable.

2.6.2 HTN104 RS-485 Network Output Wiring

Connect the NET+, NET- and COM terminals with shielded twisted pair cable meeting the specifications defined in the previous paragraph. The connection to the network must be made in a "daisy chain" configuration. "T" connections and stubs are NOT permitted. The shield should be terminated at one end on the network only. If the HTN104 is not the first or last device, set the on-board TERMINATION DIP switches for NO TERMINATION. If the HTN104 is the first or last device, set the on-board TERMINATION DIP switches to either END OF LINE or FAIL SAFE BIAS termination.

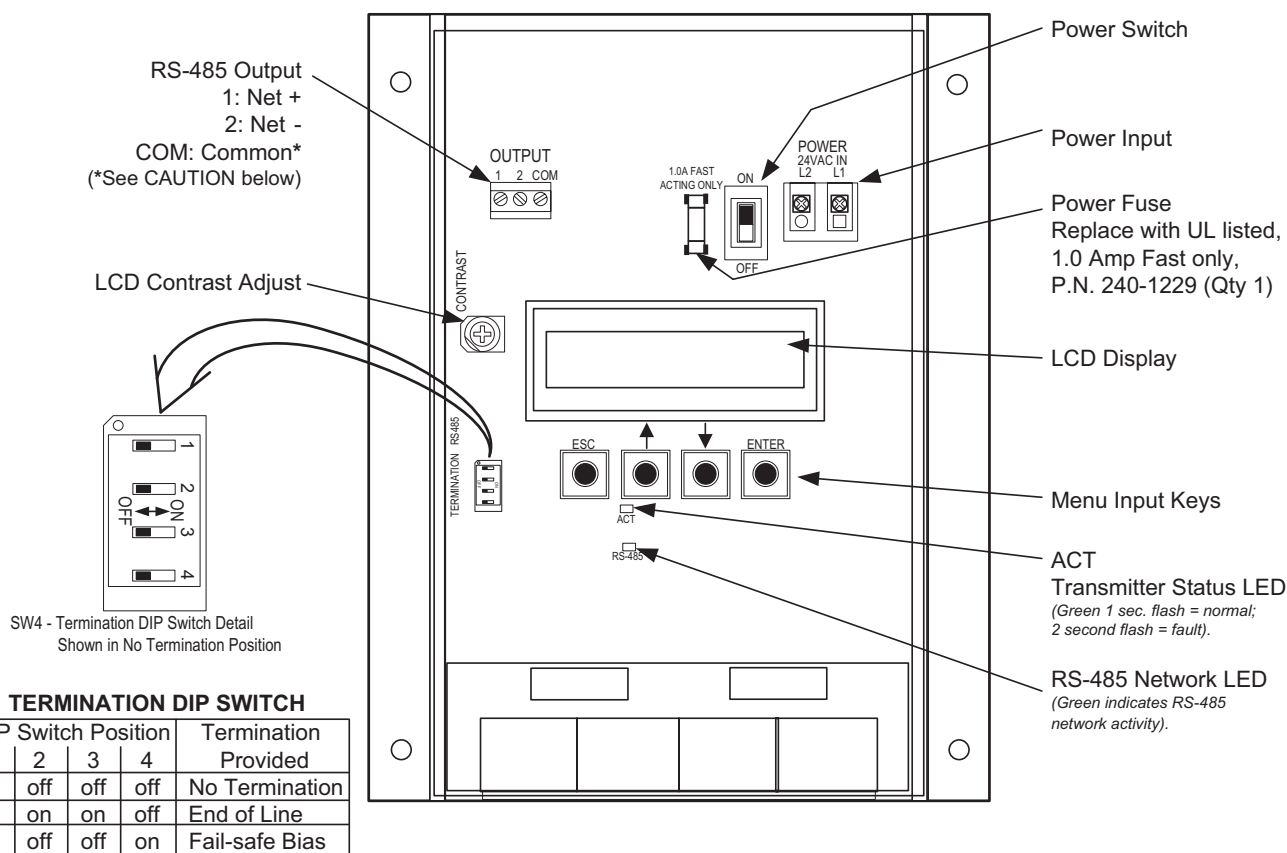

***CAUTION**

For ISOLATED output, the **COM** connection **MUST BE CONNECTED** to the network common for proper operation.

For NON-ISOLATED output, the **COM** connection **MUST BE CONNECTED** to the common ground that other network devices are using (typically the ground side of the 24VAC supply (the L2 lug of the POWER terminals). Refer to RS-485 Network Wiring Connections text for additional detail.

Figure 8. HTN104 RS-485 Transmitter Circuit Board Detail

2.6.3 HTN104 - Connecting to an RS-485 Network:

Connect the NET+, NET- and COM terminals with shielded twisted pair cable meeting the specifications defined in the previous paragraph. The connection to the network must be made in a "daisy chain" configuration. "T" connections and stubs are NOT permitted. The shield should be terminated at one end on the network only. If the HTN104 is not the first or last device, set the on-board TERMINATION DIP switches for NO TERMINATION. If the HTN104 is the first or last device, set the on-board TERMINATION DIP switches to either END OF LINE or FAIL SAFE BIAS termination.

***CAUTION**



For ISOLATED output, the COM connection MUST BE CONNECTED to the network common for proper operation.

For NON-ISOLATED output, the COM connection MUST BE CONNECTED to the common ground that is used by the other network devices (typically the ground side of the 24VAC supply; terminal L2 at the POWER connector block in Figure 8).

2.6.4 HTN104 - Transmitter Setup for RS-485 Network Operation

Network protocol, MS/TP address, device instance number and baud rate options are all selected within the NETWORK section of SETUP menu shown in Appendix A.

2.6.5 HTN104 - RS-485 Network Options and Communications Menu Settings

The transmitter is shipped from the factory with the protocol set for BACnet MS/TP Master, address 2, MS/TP Device ID 2, Baud rate of 76,800 and no termination. Initial RS-485 communications settings are accomplished within the HTN104 NETWORK sub menu shown in Appendix A. Termination is set up by the TERMINATION DIP switch SW4 as shown in Figure 8.

2.6.6 HTN104 - Setting Transmitter Termination for RS-485 Network

The HTN104 is shipped with the TERMINATION switch set for No termination, which is the recommended setting for devices installed on the network bus anywhere EXCEPT at the ends of the bus/segment. When the transmitter is connected at one end of the network or segment, it should be terminated with "End of Line" (or 120 ohm standard) termination, and the device at the other end should be terminated with "Fail Safe Bias" termination. This method provides proper network termination and ensures that the bus is in a known state during idle-line conditions (when no devices are driving the bus). EBTRON HTN104 transmitters include three termination options for "End of Line" (standard 120 ohm) and "Fail-safe Bias" (recommended at one end of the bus) or for "No Termination". Termination is selected by setting TERMINATION DIP switch SW4 shown in Figure 8. To ensure network performance, verify that the network/network segment has only one device terminated with either method as described above.

2.6.7 HTN104 - Setting RS-485 Network Protocol

Transmitter protocol can be set for BACnet MS/TP or MODBUS as shown in the NETWORK submenu (Appendix A). Tables 3 and 4 list the specific features of each protocol.

2.6.8 HTN104 - Setting Transmitter Address

The HTN104 is factory set to an address of 2. Each transmitter must be assigned a unique address between 0 and 127 for BACnet, or between 1 and 247 for Modbus prior to connecting it to the network. (See address setting in NETWORK submenu, Appendix A).

2.6.9 HTN104 - Setting Baud Rate

The HTN104 transmitter default baud rate for BACnet MS/TP is 76,800 and for MODBUS is 19,200. Baud rate can be configured in the NETWORK sub menu (Appendix A).

2.6.10 HTN104 - Setting Modbus Parity

When using Modbus communications protocol, Parity can be changed in the NETWORK submenu. Parity can be set for Even (default), Odd, None 1 (with 1 stop bit), or None 2 (with 2 stop bits).

2.6.11 HTN104 - Setting Device Instance Number

The HTN104 is factory set with a Device Instance Number of 2. Device Instance Number can be set as shown in the NETWORK submenu. Device Instance Number can also be changed to any number between 0 and 4,194,302 by writing to the Device Object's Object Identifier Property over the network.

2.6.12 HTN104 - Resetting Communications Options to Factory Default Values

To reset Communications options to factory default values, see the RESET NET submenu (Setup menu, Appendix A).

2.6.13 HTN104 BACnet Objects

Table 3 details HTN104 BACnet Objects.

Table 3. HTN104 BACnet Object Lists

| HTN104 BACnet Objects for -P, -F, -T, -U (SINGLE MODE) Sensors/Probes | | | | HTN104 BACnet Objects for -U Probes, DUAL MODE | | | |
|--|----------------------|---------------|---|---|--------------|---------------|--|
| Analog Inputs | | | | Analog Inputs | | | |
| Type, ID | Name | Default Units | | Type, ID | Name | Default Units | |
| Device | HTN104 | | | Device | HTN104 | | |
| AI, 1 | Airflow | FPM | | AI, 1 | Flow 1 | FPM | |
| AI, 2 | Temperature | °F | | AI, 2 | Flow 2 | FPM | |
| AI, 3 | Alarm Status | | 0: No alarm, 1: High Alarm 2: Low Alarm, 3: Both | AI, 3 | Temp 1 | °F | |
| | | | | AI, 4 | Temp 2 | °F | |
| | | | | AI, 5 | Alarm Status | | |
| Analog Values | | | | Analog Values | | | |
| AV, 1 | Free Area | sq.ft. | | AV, 1 | Area 1 | sq.ft. | |
| AV, 2 | Traverse Status | | 0=Disabled, 1=Flow, 2=Temp, 3=Both | AV, 2 | Area 2 | sq.ft. | |
| AV, 3 | Flow Traverse C1 | FPM | | Notes: | | | |
| ↕ | ↕ | ↕ | | User Executed Services Supported: | | | |
| AV, 6 | Flow Traverse C4 | FPM | | Subscribe COV, Read Property, Write Property, | | | |
| AV, 7 | Temperature Traverse | °F | | Device Communication Control, Who-Is. | | | |
| ↕ | ↕ | ↕ | | BACnet MS/TP | | | |
| AV, 10 | Temperature Traverse | °F | | | | | |
| Notes: | | | | | | | |
| 1. Number of AV objects is dependent on the probe count. | | | | | | | |
| 2. User Executed Services Supported: | | | | | | | |
| Subscribe COV, Read Property, Write Property, | | | | | | | |
| Device Communication Control, Who-Is. | | | | | | | |

2.6.14 HTN104 Modbus Register Map

Table 4 details HTN104 Modbus Register Maps.

Table 4. HTN104 Modbus Register Maps

| HTN104 Modbus Register Maps for -P, -F, -T, -U (SINGLE MODE) Sensors/Probes | | | | | | HTN104 Modbus Register Maps for -U Probes, DUAL MODE | | | | | | |
|--|-------------|---------|-------|-----------------------------|---|---|-------------|-------------|-------|----------------------|---|----------|
| Function | Address | Type | Units | Description | Range/Value | Function | Address | Type | Units | Description | Range/Value | |
| 2 | 10001 | boolean | | Trouble Status | 0:OK, 1:Trbl | 2 | 10001 | boolean | | Trouble Status | 0:OK, 1:Trbl | |
| 4 | 30001-30002 | float | FPM | Average Airflow | 0 to 15,000 | 4 | 30001-30002 | float | FPM | Flow 1 | 0 to 15,000 | |
| 4 | 30003-30004 | float | °F | Average Temperature | -20 to 160 | 4 | 30003-30004 | float | FPM | Flow 2 | 0 to 15,000 | |
| 4 | 30005 | word | | Number of Inserts | 0 to 4 | 4 | 30005-30006 | word | °F | Temperature 1 | -20 to 160 | |
| 4 | 30006 | word | | Alarm Status | 0: No alarm 1: High Alarm 2: Low Alarm 3: Both | 4 | 30007-30008 | word | °F | Temperature 2 | -20 to 160 | |
| 4 | 30007 | word | | Connector C1 Sensors | 0 to 4 | 4 | 30009 | word | | Number of Inserts | 0 to 4 | |
| 4 | 30008 | word | | Connector C2 Sensors | 0 to 4 | 4 | 30010 | word | | Alarm Status | 0: No alarm 1: High Alarm 2: Low Alarm 3: Both | |
| 4 | 30009 | word | | Connector C3 Sensors | 0 to 4 | 4 | 30011 | word | | Connector C1 Sensors | 0 to 4 | |
| 4 | 30010 | word | | Connector C4 Sensors | 0 to 4 | 4 | 30012 | word | | Connector C2 Sensors | 0 to 4 | |
| 4 | 30011-30018 | float | FPM | Airflow Traverse | 0 to 15,000 | 4 | 30013 | word | | Connector C3 Sensors | 0 to 4 | |
| | 30011-30012 | | | ↕ | | Insert 1 Flow | 4 | 30014 | word | | Connector C4 Sensors | 0 to 4 |
| | ↕ | | | ↕ | | Insert 4 Flow | 4 | 30015-30016 | float | Sq.Ft | Area 1 | 0 to 100 |
| | 30017-30018 | | | ↕ | | | 4 | 30017-30018 | float | Sq.Ft | Area 2 | 0 to 100 |
| 4 | 30019-30026 | float | °F | Temperature Traverse | -20 to 160 | 4 | 300202 | word | | Float word order | 0: high word first; 1: low word first | |
| | 30019-30020 | | | ↕ | | Insert 1 Temp | | | | | | |
| | ↕ | | | ↕ | | Insert 4 Temp | | | | | | |
| | 30025-30026 | | | ↕ | | | | | | | | |
| 4 | 30027-30028 | float | Sq.Ft | Area | 0 to 100 | | | | | | | |
| 4 | 300202 | word | | Float word order | 0: high word first; 1: low word first | | | | | | | |

Modbus
Modbus RTU

TM HTx104_R6A

3. HTx104 TRANSMITTER START UP

To ensure a successful start-up, verify that the airflow measuring station sensor probes and transmitter have been installed in accordance with EBTRON guidelines.

Before powering the transmitter, verify proper physical installation, power connections and model specific signal wiring. Note that the HTN104 must be properly configured for the desired system network protocol prior to operation. Review the previous section of this document for the network settings. If assistance is required, contact EBTRON Customer Service, toll free at 800-232-8766.

Move the power switch to the “ON” position. The transmitter executes a complete self-check each time the power is turned on that takes 10 seconds to complete. The LCD will display current airflow and temperature. Refer to Tables 3 and 4 for network status outputs.

3.1 Changing the System of Units - IP or SI Units

The HTx104 transmitter is provided with the system of units set to IP. To change to SI units, simultaneously press and release the “ENT” and “ESC” buttons during normal operation. “IP/SI UNITS” will be indicated on the LCD display. Refer to Appendix A SYSTEM OF UNITS MENU for details on the System of Units menu. Note that Setup Menu items are shown in IP System Of Units. When SI System of Units is selected, the units of measure abbreviations used in the menus is shown in Table 5.

Table 5. Standard “IP” and “SI” Menu System of Units Abbreviations

| “IP” System of Units LCD Display | Description | “SI” System of Units LCD Display | Description |
|-------------------------------------|-----------------------|-------------------------------------|-------------------|
| FPM | Feet per minute | MPS | Meters per second |
| CFM | Cubic feet per minute | LPS | Liters per second |
| SQF | Square feet | SQM | Square meters |
| F | Fahrenheit | C | Celsius |

3.2 HTx104 Transmitter Calibration

The HTx104 uses high quality industrial grade components and is designed for years of trouble-free operation. Periodic recalibration of the transmitter is neither required or recommended. Transmitter field calibration verifiers are available for purchase from EBTRON for installations requiring periodic validation of instrumentation. Contact EBTRON for more information.

3.3 HTx104 LCD Display Notifications

Following the brief initialization at power up, the LCD display automatically displays airflow and temperature with units of measurement in all upper case (caps) characters. The display provides additional information on system status and alarm conditions. Refer to the ALARM FEATURES section of this manual for additional detail on Alarm and Trouble Error code indications.

3.3.1 LCD Display when using Dual Mode with Two Universal Probes

When the HTx104 is set for Dual Mode with two Universal Probes, the LCD automatically cycles through and displays airflow and temperature from each Universal probe. A HOLD feature in the permits the user to hold the display at a particular probe reading at any time simply by depressing any of the Menu Item Keys (ESC, \downarrow , or ENTER). The display will also indicate the asterisk symbol “*” on the far right side of the display when it is in this HOLD state. To resume normal cycling through the probe readings, simply depress the ESC key. Refer to the menus and descriptions in the Setup menu of Appendix A for additional detail.

TM HTx104_P6A

3.4 Factory Default Menu Settings

Table 6 shows the factory default settings for all compatible sensor probes. To change the Factory Default Settings, see: CHANGING FACTORY DEFAULT SETUP MENU SETTINGS.

Table 6. Factory Default Menu Settings

| Display | Description | I-P | S.I. |
|--|---|--|-------------------------------------|
| AIRFLOW= | Airflow measurement method, Actual or Standard. | ACT | ACT |
| *LCDU/M= | Airflow units of measure | ACFM | LPS |
| *AREA= | Free area where station is located (required for volumetric measurement) | 0.00 sq.ft. (see note) | 0.000 sq.meters (see note) |
| *A01 SGNL= | HTA104 output 1 signal type voltage or mA (airflow) | mA | mA |
| *A01 UM= | Output 1 units of measure | AFPM | MPS |
| *A01 FS= | HTA104 output 1 signal full scale | 5,000 FPM (dependant on probe type) | 25 MPS (dependant on probe type) |
| *LLIMIT= | Low limit cutoff | 0 AFPM | 0 MPS |
| *FLOW ADJ= | Offset-Gain On/Off | Off | Off |
| *GAIN= | Gain factor | 1.000 | 1.000 |
| *OFF= | Offset factor | 0.000 | 0.000 |
| *TEMP METH= | Temperature Averaging | Weighted Avg. | Weighted Avg. |
| *A02 SGNL= | HTA104 output 2 signal voltage or mA (temperature or alarm) | mA (see alarms) | mA (see alarms) |
| *A02 MS= | HTA104 output 2 signal minimum scale | -20° F | -30° C |
| *A02 FS= | HTA104 output 2 signal full scale | 160° F | 70° C |
| *LCD INTG= | Number of flow calculations to be averaged for LCD display. | 100 | 100 |
| For HTA104: *A01 INTG= For HTN104: NET INTG | Number of flow calculations to be averaged for A01 output. | 30 | 30 |
| *ALT= | Altitude for flow correction relative to mean sea level (0 ft). | 0 ft | 0 m |
| *A02 ASGN = | HTA104 Output 2 Assigned Type: Temperature/Alarm | TEMP | TEMP |
| *SETPNT= | Alarm setpoint value. Operates in conjunction with TOL= value. | 0 | 0 |
| *TOL= | Alarm range tolerance value. This setting establishes the alarm range relative to the SETPNT= value. | 10% | 10% |
| *NO FAULT= | Sets the A02 normal (not alarm) output state relative to the full scale analog output selected. HI provides maximum full scale under normal conditions and minimum scale during alarm. LO provides minimum full scale under normal conditions and maximum scale during alarm. (HTA104 Only) | HI | HI |
| *DELAY= | Time that the alarm condition must exist before alarm output is activated. | 2 minutes | 2 minutes |
| *ZERO OFF = | Set to YES to inhibit LO alarm condition when flow reading is zero (dependent on LLIMIT= setting). Set to NO to disable this feature. | NO | NO |
| *RESET = | Set to AUTO to have alarm self-clear when alarm condition no longer exists. Set to MANUAL to require manual reset of alarm. | AUTO | AUTO |

Note: For HP1 probes, area is stored in one-wire, but can be changed.

3.5 Changing Factory Default Setup Menu Settings

3.5.1 Setup Menu Options

The HTx104 Transmitter is setup and configured at the factory to be fully operational when sensor probes are connected and powered up. Factory settings can easily be changed using the SETUP MENU by simultaneously pressing and releasing the “UP” and “DOWN” buttons while the transmitter is in its normal operating mode. Navigate through the menu using Appendix B to make changes to the transmitter configuration. The settings take effect immediately. The following paragraphs detail common field modifications to the factory default settings.

3.5.2 Selecting Actual and Standard Output Measurement Type

The transmitter is set from the factory to provide actual airflow measurement units (displayed as “ACFM” and “AFPM”). In this mode, airflow measurements are calculated for actual airflow conditions. If using Actual airflow, corrections for altitude are entered through the **ALT=** setting in the Setup menu. If desired, the output can be set to provide standard airflow measurement units (displayed as “SCFM” and “SFPM”) which provides measurements that are corrected to standard conditions.

3.5.3 Output Scaling

EBTRON's airflow sensors are individually calibrated between 0 and the factory default full scale in wind tunnels to standards traceable to the National Institute of Standards and Technology (NIST). Sensors are independent and produce "percent of reading" accuracy. Changing the full scale does not change the accuracy of the device. Factory default output scaling for analog HTx104 transmitters can be changed using setup menus of Appendix B.

3.5.4 Changing the LCD Display from Volumetric Flow CFM to Velocity FPM

The default LCD UM is dependent on the probe type connected. To change to ACFM or AFPM see DISPLAY submenu in the SETUP menus. Changing the LCD units does not affect analog or network output units.

3.5.5 HTA104 Converting the Analog Output Signal from FPM to CFM

The HTA104 analog output transmitter is shipped from the factory with analog output "OUTPUT 1" set to indicate velocity in AFPM. To automatically convert this analog velocity output to volumetric flow (ACFM), simply set the *AO1 UM from AFPM (default) to ACFM in the SETUP menu. If you wish to manually convert the velocity output to volumetric flow (ACFM), simply multiply the indicated output velocity (in FPM) by the free area of the air flow probe installation location. Refer also to Table 7 for a complete listing of conversions for each of the analog outputs of the HTA104. The AO1 full scale analog output (OUTPUT1) value is determined by the AO1 FS setting within the SETUP menu.

Table 7. HTA104 Analog Output Conversions

When OUTPUT 1 is Configured as Linear Airflow (FPM, MPS):

| TO CONVERT TO | ANALOG OUTPUT SCALING AND TYPE | | |
|--------------------|-------------------------------------|------------------------------------|---|
| | 0-10 VDC | 0-5 VDC | 4-20 mA |
| Airflow (FPM, MPS) | Output Voltage/10 x FS1 | Output Voltage/5 x FS1 | (Output Current-4)/16 x FS1 |
| Airflow (CFM) | Area (SQF) x Output/10 x FS1 | Area (SQF) x Output/5 x FS1 | Area (SQF) x (Output - 4)/16 x FS1 |
| Airflow (LPS) | Area (SQM) x Output/10 x FS1 x 1000 | Area (SQM) x Output/5 x FS1 x 1000 | Area (SQM) x (Output - 4)/16 x FS1 x 1000 |

When OUTPUT 1 is Configured as Volumetric Airflow (CFM, LPS):

| TO CONVERT TO | ANALOG OUTPUT SCALING AND TYPE | | |
|--------------------|--------------------------------|------------------------|-------------------------------|
| | 0-10 VDC | 0-5 VDC | 4-20 mA |
| Airflow (CFM, LPS) | Output Voltage/10 x FS1 | Output Voltage/5 x FS1 | (Output Current - 4)/16 x FS1 |

When OUTPUT 2 is Configured as Temperature (°F, °C):

| TO CONVERT TO | ANALOG OUTPUT SCALING AND TYPE | | |
|---------------|------------------------------------|-----------------------------------|--|
| | 0-10 VDC | 0-5 VDC | 4-20 mA |
| Temp (°F, °C) | Output Voltage/10 x (FS2-MS2) +MS2 | Output Voltage/5 x (FS2-MS2) +MS2 | (Output Current - 4)/16 x (FS2-MS2) +MS2 |

NOTES:

- FS1 is AO1 full scale analog output value from ANALOG OUT MENU.
- FS2 is AO2 full scale analog output value from ANALOG OUT MENU.
- MS2 is AO2 minimum scale analog output value from ANALOG OUT MENU.

3.5.6 Locking the Configuration Settings

The HTx104 transmitter configuration settings can be locked at one of three security levels within the SECURITY submenu using the LOCK SEC= item.

When LOW security level is selected (LOCK SEC=LOW) the last 4 digits of the board serial number are automatically assigned as the lock code. To see the board serial number, navigate to DIAGNOSTICS menu in SERIAL NUMBERS item. When the MED security level is selected (LOCK SEC=MED) the user enters and confirms a security code. In the event that this code is lost/misplaced, EBTRON can provide a key that is unique to the transmitter to unlock it. Contact EBTRON customer service for this code.

When the HIGH security level is selected (LOCK SEC=HIGH) the user enters and confirms a security code. In the event that this code is lost/misplaced, the transmitter must be returned to the factory in order to unlock it.



When LOCK SEC=HIGH is selected, the user defined setting can only be changed after entering the user defined code. **STORE THE LOCK CODE IN A SAFE LOCATION!** For security reasons, the HIGH level lock code can only be reset by returning the transmitter to the factory.

3.6 HTx104 - Alarm Features

For analog output model HTA104, analog output A02 (OUT2) can be assigned to function as an alarm output. The A02 alarm output can be assigned in the SETUP menu to operate as an average alarm (A02 ASGN=ALRM) or as a trouble alarm (A02 ASGN=TRBL) for monitoring the status of the transmitter and sensors. The A02 ASGN= setting is located in the ANALOG OUT submenu of the SETUP menu. The transmitter LCD display will indicate the Alarm status for 2 seconds, and will cycle through any other alarms if multiple alarm events are active for 2 seconds each, and then display the current actual flow for 2 seconds. The following paragraphs detail the alarm types. Detailed set up of the Alarm features is shown in the Setup menu.

For the RS-485 network model HTN104, operation is the same with the relevant network objects reflecting transmitter/alarm status. Refer to Tables 3 and 4 for detail.

3.6.1 No Fault (NO FAULT=HI)

On HTA104, when A02 output is assigned as Alarm or Trouble, this setting configures the normal output condition to be HI or LO relative to the full scale analog output level selected when no fault condition exists.

3.6.2 Alarm Indications

Table 8 details the alarm types, LCD indications and alarm output indications for each transmitter type. User can select either or both of the two Average Alarms or the Trouble Alarm.

3.6.3 Low Alarm - "LO ALRM= ON"

The Low Alarm is activated when the average airflow falls to a defined level below the SETPNT= value. The defined level is equal to the SETPNT= value minus the calculated value of (TOL= value * SETPNT= value). Once active, the alarm can be cleared when the average airflow rises above the set point minus calculated tolerance value.

3.6.4 High Alarm - "HI ALRM= ON"

The High Alarm is activated when the average airflow rises above a defined level below the SETPNT= value. The defined level is equal to the SETPNT= value plus the calculated value of (TOL= value * SETPNT= value). Once active, the alarm can be cleared when the average airflow falls below the set point plus calculated tolerance value.

3.6.5 Trouble Alarm - "A02 ASGN=TRBL"

The Trouble alarm provides trouble codes useful for isolating setup issues or problems within the transmitter or sensors. The transmitter LCD will indicate TROUBLE! regardless of whether A02 is assigned to TRBLE. The Diagnostic submenu can be engaged for the error code and a brief description of the trouble. Contact EBTRON customer service for information on troubleshooting using the Trouble error codes.

Table 8. HTx104 Alarm Types and Notifications

| ALARM OUTPUT ASSIGNMENT TYPE | LOCAL LCD DISPLAY OF ALARM TYPE AND NOTIFICATION | ANALOG OUTPUT 2 ALARM INDICATION | NETWORK ALARM INDICATION |
|---|--|--|---|
| **LOW ALARM** (Average Alarm) | Display alternates between **LOW ALARM** (then any other alarms) and actual reading for 2 seconds each. | On alarm or trouble, OUT2 is active high (or active low) relative to the full scale maximum (or minimum) analog value as determined by the SETUP Menu "NO FAULT=" selection. Individual sensor velocities can be viewed using the Diagnostics submenu. | Alarm Status is available at BACnet Objects and Modbus Registers. Refer to BACnet Objects List and Modbus Register Map for additional detail. |
| **HIGH ALARM** (Average Alarm) | Display alternates between **HIGH ALARM** (then any other alarms) and actual reading for 2 seconds each. | | |
| TROUBLE ! (Trouble Alarm) | Display indicates TROUBLE ! (Refer to DIAGNOSTIC menu to obtain a brief description of the error and any other alarms). | | |

TM HTx104_R6A

3.6.6 Zero Off Setting - "ZERO OFF=NO"

The ZERO OFF setting works with the Low Alarm. When set to "YES" there will be no alarm indication if average airflow falls below the LLIMIT value.

3.7 Viewing Sensor Data

3.7.1 Local Sensor Data Display

Airflow and temperature of individual sensors can be displayed locally on the LCD from the diagnostic menu as detailed in Setup Menu of Appendix A. On model HTN104, they can also be read over the RS-485 network. Sensors are automatically addressed after power is applied to the transmitter. The probe that is connected to the left most **used** receptacle on the transmitter is probe number 1. The lowest sensor number on the probe is at the end opposite the connecting cable. Up to 4 sensors (addresses 1 to 4) can be individually viewed.

3.7.2 Viewing Sensor Data over RS-485 BACnet and Modbus Networks

BACnet analog variables and Modbus registers are available that describe individual airflow (**Airflow Traverse**) and temperature data (**Temperature Traverse**) from the transmitter. Refer to BACnet Object List and Modbus Register Map of Tables 3 and 4 for additional detail.

Note that if only average data is desired, the mounting position of the probes is not critical. When a probe is disconnected and then plugged in to a different port, the transmitter will re-discover it within 15 seconds and make any necessary addressing adjustments. To standardize installation and decoding of data, EBTRON recommends a left to right (or top to bottom in vertical applications) sensor probe mounting convention as detailed in the separate sensor probe installation instructions.

4. FIELD ADJUSTMENTS

4.1 Altitude Correction Adjustment

The Altitude Correction Adjustment allows for correction of airflow readings at the installed site altitude and more precise readings regardless on installed altitude. Refer to the SETUP MENU of Appendix B for the *ALT= menu item, and set this value to the installation altitude. This adjustment is only necessary when AIRFLOW=ACT.

4.2 Adjusting the Low Limit Cutoff

The low limit cutoff forces the output signal for the airflow rate to zero whenever the airflow rate calculated falls below the specified Low Limit value. This feature is useful on outside air intakes that often indicate false airflow rates, induced by transient wind gusts or when the intake damper is closed and there is no net flow across the damper. Readings of 100 FPM or more are not uncommon on many outside air intake applications when the intake damper is closed and are a result of air movement in the intake plenum (not a malfunction in the airflow measuring device). Setting the low limit to a value significantly below the control setpoint and higher than the threshold flow for false wind readings simplifies control and interpretation of the airflow rate signal on many applications. To set the low limit cutoff, enter the Setup menu and set "*LLIMIT={desired value in FPM (MPS in SI units)}" as shown in Appendix B.



Fluctuations in the airflow output signal are normal. EBTRON's laboratory research indicates that dampening true fluctuations will result in poor control and a larger dead-band of operation.

4.3 Factory Calibration Adjustments

The factory calibration should not require adjustment if the sensor probes are installed in accordance with published installation guidelines. However, some installations may not meet placement guidelines, or commissioning requirements may dictate field adjustment. Field adjustment may improve the "installed accuracy" of systems when determining volumetric flow rates. Only the airflow rate can be adjusted. Ensure that the reference device and technique used to determine the airflow rate in the field are suitable for such measurement. Select a location that is acceptable for the device being used as the reference, recognizing that this may not be the same location where the EBTRON airflow station is installed. The inherent accuracy of field measurement will not be better than $\pm 5\%$ of reading and can often exceed $\pm 10\%$. Do not adjust the output of the transmitter if the difference between the transmitter and the field measurement is less than 10%.

4.4 Automated Field Adjustment using the Field Adjust Wizard

4.4.1 Overview of the Field Adjustment Wizard

The simple to use Field Adjustment Wizard provides a one or two point automated menu driven field adjustment to factory calibration of the OUTPUT 1 airflow rate signal.

4.4.2 Engaging and Using the Field Adjustment Wizard

Use Appendix B to navigate to the FIELD ADJUST submenu. Appendix B provides details of the FIELD ADJUST WIZARD menu and how to use it in applications for one or two point automated field adjustment. If you wish to disable the FIELD ADJUST setting, navigate to the ADJUSTMENTS submenu and set FLOW ADJ=OFF.

4.5 Manual Adjustment of Factory Offset/Gain Calibration

If you prefer, you can instead perform a manual adjustment at one or two points. The transmitter firmware can be adjusted for Output 1 signal “gain” and “offset”. To adjust the output signal “gain”, the “FLOW ADJ” override must be set to “*FLOW ADJ=ON” from the Setup Menu. The adjustments affect both the LCD display and output signal. When “*FLOW ADJ=OFF” is set, adjusting the output signal “offset” and/or “gain” does not affect the transmitter output.

4.5.1 Procedure for 1 Point Field Adjustment

Select an airflow rate that represents a valid operating condition for the system. Set fan speed, dampers and VAV boxes to a fixed speed or position when measurements are taken. Complete the following worksheet to determine the gain setting to be set on the transmitter.

1. Enter the setup menu and set “*FLOW ADJ=OFF”. This is the factory default setting and disables any adjustments, returning the unit to its original factory calibration.
2. _____ Record the transmitter output by taking the visual reading from the transmitter LCD. Readings can be taken by the host controls if the output signal conversion has been confirmed. Time averaging the data will improve field recalibration.
3. _____ Record the reference reading. Make sure that the unit of measure (FPM, CFM) is identical for both the transmitter and the reference. If the unit of measure is velocity (FPM), make sure that the reference airflow measurement was corrected for the area where the measurement was taken.
4. _____ Calculate the gain factor (m): **m=line 3/line 2.**
5. Enter the setup menu and set “*FLOW ADJ=ON”.
6. Set “*GAIN={value calculated in line 4}”.
7. Confirm that “*OFF=0.00”.
8. Press the “ESC” button until you return to the normal operating mode. Field adjustment is complete.

Procedure for 2 Point Field Adjustment

Select the minimum and maximum airflow rate that the airflow station will encounter as a valid operating condition for the system. Set fan speed, dampers and VAV boxes to a fixed speed or position when measurements are taken. Complete the following worksheet to determine the gain and offset settings to be set on the transmitter. Measurement units can be in either FPM or CFM, but they need to be the same between transmitter and reference. When using FPM, ensure that area for both measurements is the same.

1. Enter the setup menu and set “*FLOW ADJ=OFF”. This is the factory default setting and disables any adjustments, returning the unit to its original factory calibration. OBSERVE AND APPLY MEASUREMENT UNITS FOR CONSISTENCY BETWEEN TRANSMITTER AND REFERENCE.
2. Set the minimum airflow rate.
3. _____ Record the transmitter airflow rate by taking the visual reading from the transmitter LCD. Readings can be taken by the host controls if the output signal conversion has been confirmed. Time averaging the data will improve field recalibration.
4. _____ Record the reference airflow rate. Make sure that the reference airflow measurement was corrected for the area where the measurement was taken.
5. Set the maximum airflow rate.
6. _____ Record the transmitter airflow rate.
7. _____ Record the reference airflow rate.
8. _____ Calculate the gain factor (m): **m=(line 7 - line 4)/(line 6 - line 3).**
9. _____ Calculate the offset factor (b): **b=(line 4 - (line 8 x line 3)).**

If more than 2 points are available, perform a linear regression on the data to determine gain and offset.

10. Enter the setup menu and set “*FLOW ADJ=ON”.
11. Set “*GAIN={value calculated in line 8}”.
12. Set “*OFF={value calculated in line 9}”. Note that OFFSET must be entered in FPM. If measurements were recorded in CFM then values need to be divided by duct area before entering in transmitter.
13. Press the “ESC” button until you return to the normal operating mode. Field adjustment is complete.

5. STANDARD LIMITED PARTS WARRANTY

If any **EBTRON** product fails within 36 months from shipment, **EBTRON** will repair/replace the device free of charge as described in the company’s warranty contained in **EBTRON**’s *TERMS AND CONDITIONS OF SALE*. Defective equipment shall be shipped back to **EBTRON**, freight pre-paid, for analysis.

6. MAINTENANCE

When the transmitter and probes are installed in accordance with **EBTRON** guidelines, instrument difficulties are rare. Issues can be easily resolved by viewing Diagnostic data from the Diagnostic Menu and by proceeding through the troubleshooting guides of Tables 9 through 11. All devices come with a 3-Year Warranty on Parts and Factory Labor, as well as lifetime, toll-free customer support. Customer support is available Monday through Thursday from 8:00 AM to 5:00 PM ET, and Friday from 8:00 AM to 2:30 PM ET at 800-2**EBTRON** (232-8766). **EBTRON** Diagnostic Customer Service forms are available on-line at www.ebtron.com. These forms are designed to assist us in quickly responding to and accurately diagnosing your specific issue and will greatly expedite its resolution. A sketch of the installation location, along with a control sequence of operations is very useful and is recommended to help us diagnose any issue you may encounter. Fax the completed information to 843.756.1838 before you call, and have it available when speaking with our Customer Service representative. Address all correspondence to the **EBTRON** Customer Service Department. Additional information is also available from your local **EBTRON** representative.

6.1 General Troubleshooting (All HTx104 Systems)

Table 9. General Troubleshooting (All HTx104 Systems)

| Problem | Possible Cause | Remedy |
|---|--|---|
| No LCD display indication and the green 'ACT' transmitter status LED on the main circuit board is not illuminated. | Power switch not in the "ON" position. | Move the power switch to the "ON" position. |
| | Improper supply voltage to the power input terminal block. | Ensure that 24VAC power is connected to L1 and L2 of the POWER terminal block and that the voltage with the power switch in the "ON" position is between 22.8 and 26.4 VAC. |
| | Blown fuse. | Check power wiring. Ensure that multiple devices wired on a single transformer are wired "in-phase". Replace fuse only with a 1.0 amp, fast-acting fuse after the problem has been identified and corrected. |
| No LCD display indication and the green 'ACT' transmitter status LED on the main circuit board is flashing. | LCD contrast too low. | Turn "Contrast" potentiometer on the main circuit board "clockwise". |
| The LCD display is scrambled or there is no LCD display indication after touching the switches, LCD display or circuit board. | Static electricity. | Touch an earth-grounded object, such as a duct, to discharge static electricity then reset the power. Avoid direct contact with the LCD display or circuit board. |
| The LCD display indicates "No Probes". | The power switch on the transmitter was moved to the "ON" position before the sensor probes were connected. | Reset 24VAC power by moving the power switch from the "ON" to "OFF" position and then back to the "ON" position. |
| The LCD display indicates "DiffSensor Type". | Sensor probes have been mismatched. | Transmitters must have the same sensor type connected (HP1, HF1, HB1, HT1 or HU1 sensor probes). |
| The LCD display indicates "Too Many Sensors". | A probe with 2 or more sensors has been connected to a 'Type C' transmitter with 4 receptacles. | Probes with 2 or more sensors are shipped with and require a 'Type B' transmitter with 2 receptacles. |
| The green 'ACT' transmitter status LED on the main circuit board is "ON" but not flashing. | The microprocessor is not running. | Reset 24VAC power by moving the power switch from the "ON" to "OFF" position and then back to the "ON" position. |
| The green 'ACT' transmitter status LED on the main circuit board is flashing at 1-second intervals. | No problem, normal operation. | No remedy required. |
| The green 'ACT' transmitter status LED on the main circuit board is flashing at 2-second intervals. | The sensor detection system has detected one or more malfunctioning or missing sensors. | Check sensor probe cable connections. If sensor probe connections look OK and match the number of sensor probes indicated on each probe's hang tag, please call EBTRON's customer service department or visit us at www.ebtron.com . |
| | A probe with 2 or more sensors has been connected to a 'Type C' transmitter with 4 receptacles. | Probes with 2 or more sensors are shipped with and require a 'Type B' transmitter with 2 receptacles. |
| The transmitter indicates airflow when the HVAC system is not operating. | Sensors are sensitive and can measure very low air velocities. If a reading is indicated, there is airflow present where the airflow measuring station is located. | Do not attempt to adjust zero ("offset"); doing so will result in an error in airflow measurement. The Low Limit airflow cutoff value can be set to force the output signal to zero. |

6.2 HTA104 - Analog Transmitter Troubleshooting

Table 10. HTA104 Analog Transmitter Troubleshooting

| Problem | Possible Cause | Remedy |
|---|--|--|
| No output signal can be measured at the OUTPUT terminal block of the HTA104 transmitter. | Blown output fuse (output 1 and output 2 are fused and protected independently on HTA104 transmitters). | Make sure that power has not been connected to the output terminal block. Correct the problem and replace with 0.125 amp, fast acting fuse only. Make sure that the host control system is not configured for a 2-wire device (no excitation voltage should be present on the signals from the host controls). Correct the problem and replace with 0.125 amp, fast acting fuse only. |
| | The Low Limit airflow cutoff value is above the actual airflow reading. | Decrease the Low Limit airflow cutoff value in the Setup Menu until it is below the actual airflow reading. |
| The output signal on the HTA104 transmitter fluctuates while the airflow and/or temperature readings on the LCD are steady. | Electrical interference from other devices is creating noise in the signal wires to the host control system. | The output signal wiring must be shielded. Individually ground one or more of the following points: the signal wire shield at host controls; signal wire shield at the transmitter, or L2 of the power terminal block of the HTA104. |
| The LCD display does not match the readings indicated by the host control system. | The scaling in the host control system is incorrect. | Compare the current configuration of the transmitter with that of the host control system. Compare the minimum and full scale settings for each output by navigating through the Setup Menu. |

6.3 HTN104 - RS485 Transmitter Troubleshooting

Table 11. HTN104 RS-485 Transmitter Troubleshooting

| Problem | Possible Cause | Remedy |
|--|---|--|
| The host control system is unable to communicate with the HTN104 transmitter. | The network signal wiring is not properly connected to the HTN104 transmitter or the host controls. | Verify that the network signal wires from the host controls are connected to the proper terminals of the OUTPUT block. On the HTN104 transmitter OUTPUT terminal block, NET+ is for A, NET- is for B and COM for common. |
| | The network protocol is not properly set in the HTN104. | Set network protocol based on the network requirements and reset transmitter power. Refer to NETWORK setup menu, Appendix A of this technical manual. |
| | The network address is not properly set in the HTN104. | Set network address based on network requirements and reset transmitter power. Refer to NETWORK setup menu, Appendix A of this technical manual. Note that each address must be unique for the network. |
| | The termination is not properly set in the HTN104. | Set transmitter termination based on network requirements and reset the transmitter power. Refer to the section describing network termination and Figure 8 of this technical manual for settings. |
| The LCD display does not match the readings indicated by the host control system. | The Area of the HTA104 transmitter does not match that of the host controls. | Compare the value of the Area of the HTN104 transmitter with that of the host control system and make adjustments in SETUP menu to ensure a match. Refer to the appropriate SETUP menu for the probe type in use within this technical manual for Area settings. |
| The returned value for airflow is zero when airflow is indicated on the LCD display of HTN104 transmitter. | The Low Limit airflow cutoff value is above the actual airflow reading. | Decrease the Low Limit airflow cutoff value in the Setup Menu until it is below the actual airflow reading. |
| The status point from the HTN104 transmitter has a Trouble value. | The sensor detection system has detected one or more malfunctioning or missing sensors. | Check sensor probe cable connections. If sensor probe connections look OK and match the number of sensor probes indicated on each probe's hang tag, please call EBTRON 's customer service department or visit us at www.ebtron.com . |

TM_HTX104_16A

APPENDIX A - HTx104 SETUP MENUS

TM_HTx104_R6A

HTx104 Fan Sensor Setup Wizard

FAN SENSOR SETUP WIZARD

Launched at initial power-up when Fan Sensors are attached to transmitter, and if Setup Wizard was not completed.

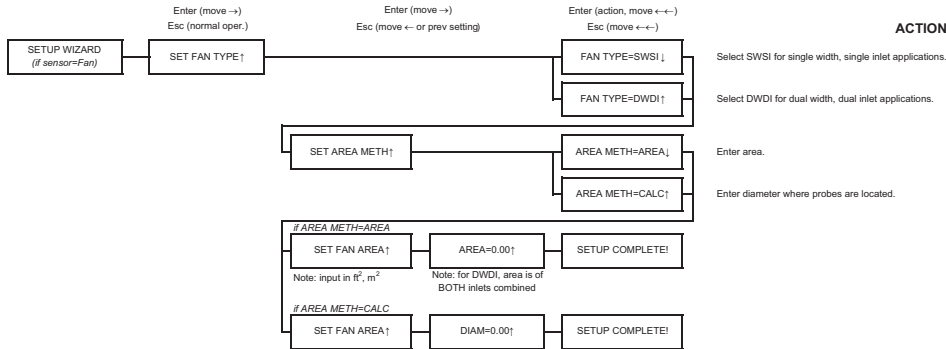

HTx104 Universal Probe Setup Wizard

UNIVERSAL PROBE SETUP WIZARD

Launched at initial power-up when Universal Probes are attached to transmitter, and if Setup Wizard was not completed.

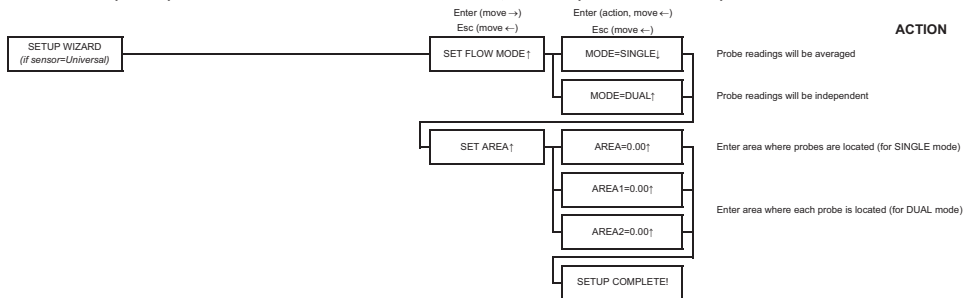

HTx104 System of Units Menu

SYSTEM OF UNITS MENU

Simultaneously depress/release ENTER + ESC keys during normal operation to select

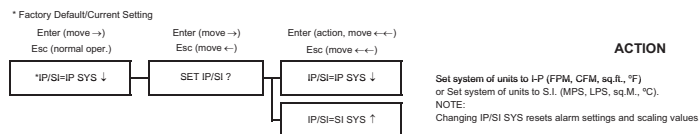

HTx104 Setup Menu Options

Part 1 of 5

SETUP MENU

Simultaneously depress/release ↑ + ↓ keys during normal operation to select

* Factory Default/Current Setting

Enter (move →) Enter (move →) Enter (move →) Enter (move →) Enter (action, move ←→)
Esc (normal oper.) Esc (move ← or prev setting) Esc (move ← or prev setting) Esc (move ←) Esc (move ←→)

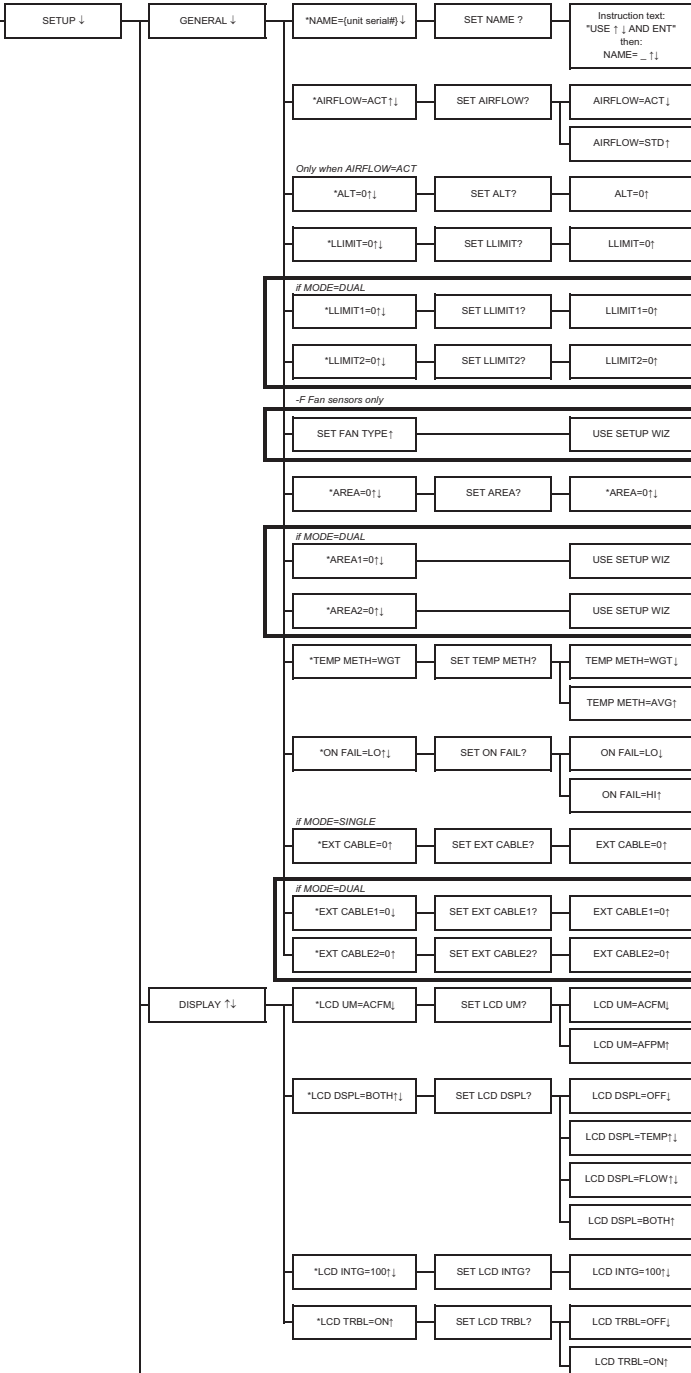

ACTION

Custom LCD Flow Text: Blinking prompt at position of the selected character. Character is selected using the up and down arrows and then ENTER to accept and move cursor forward (right); ESC moves the cursor back (left). Use space characters for blank or unwanted text.

Set the airflow measurement to ACTUAL units (AFPM/ACFM)

Set the airflow measurement to Standard units (SFPM/SCFM)

Set the altitude above sea level for flow correction: 0 to 18,000 ft.

Enter airflow setpoint value below which the transmitter outputs zero flow.

Enter setpoint for velocity (FPM) for probe 1 that the transmitter will output as zero for airflow when average airflow reading is below setpoint.

Enter setpoint for velocity (FPM) for probe 2 that the transmitter will output as zero for airflow when average airflow reading is below setpoint.

- USE SETUP WIZ flashes to indicate that these items are set in the SETUP WIZARD menu (located in TOOLS).

Enter area where probe(s) is/are located.
Note: For -U probes and -F sensors, "USE SETUP WIZ" flashes to indicate that this item is set in the SETUP WIZARD menu (located in TOOLS).

- USE SETUP WIZ flashes to indicate that these items are set in the SETUP WIZARD menu (located in TOOLS).

- USE SETUP WIZ flashes to indicate that these items are set in the SETUP WIZARD menu (located in TOOLS).

Set temperature output for velocity weighted average of temperature sensors.

Set temperature output for mathematical average of temperature sensors.

Sets transmitter analog output state in the event of a major fault (all sensor failure) expressed as HI for full scale analog output or LO as minimum scale analog output.

Enter length of extension cable

Enter length of extension cable for probe 1

Enter length of extension cable for probe 2

Set LCD airflow display units to CFM or FPM. (Note: A-ACT or S-STD measurement prefix is set by AIRFLOW= setting above). When changing to ACFM, be sure to set AREA.

Set what is displayed on LCD

Integration samples for LCD.

Set whether or not TROUBLE will display on LCD during a trouble condition.

TO PART 4 'A' TO PART 2

TM_HTx104_R6A

HTx104 Setup Menu Options

Part 2 of 5

FROM PART 1

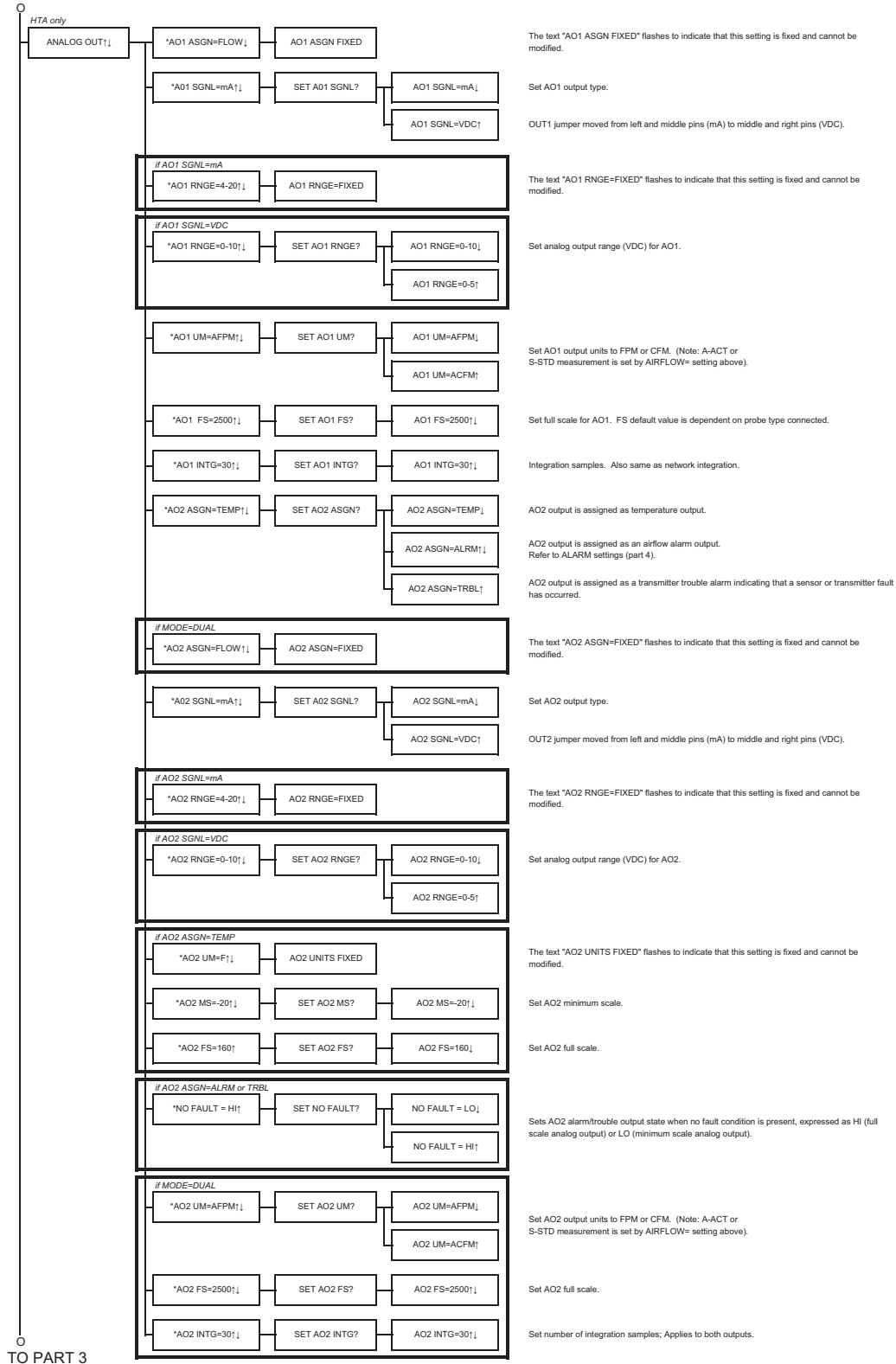

TO PART 3

TM_HTx104_R6A

HTx104 Setup Menu Options

Part 3 of 5

FROM PART 2

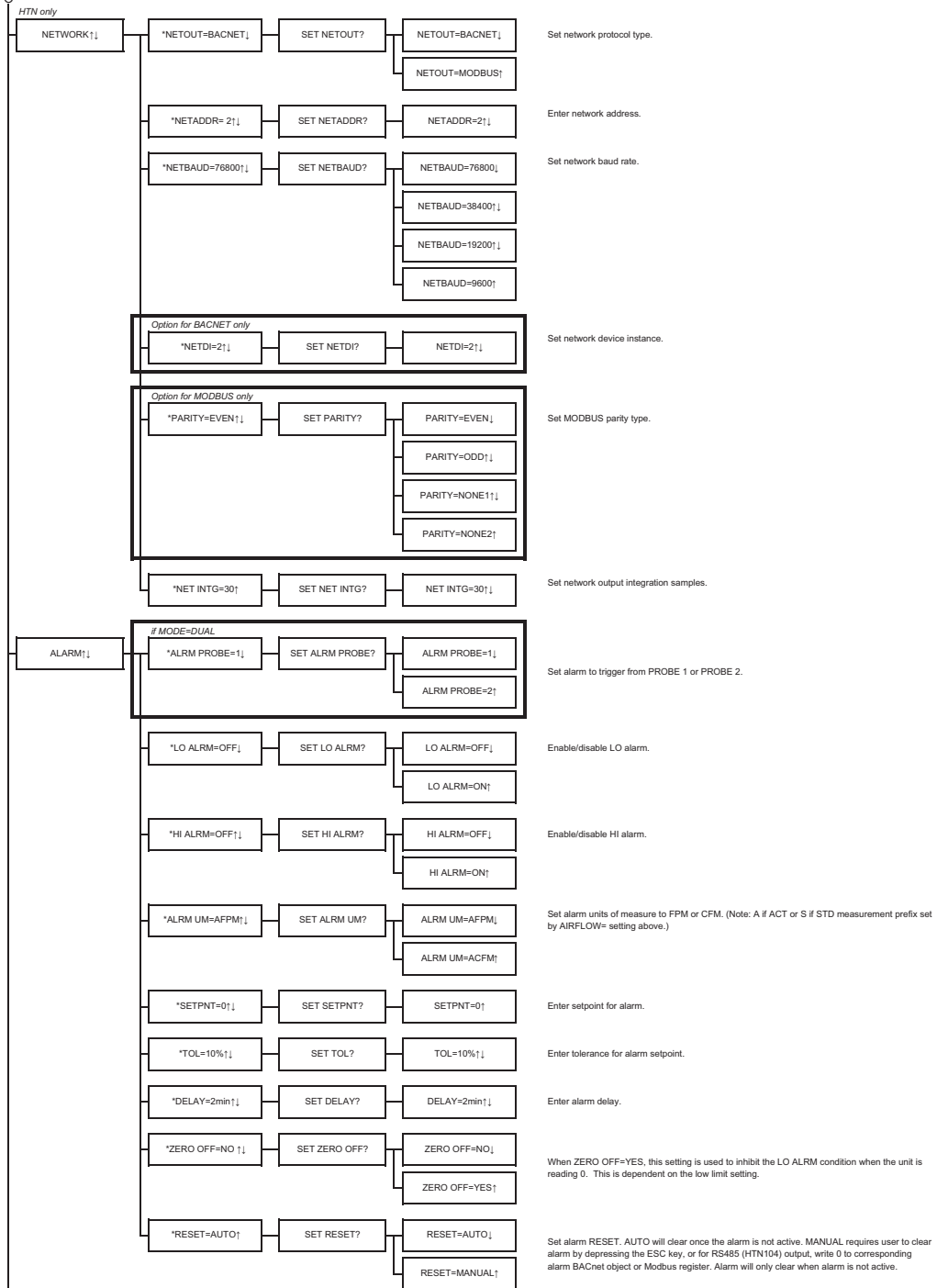

TM HTx104_R6A

TO PART 4 'B'

HTx104 Setup Menu Options

Part 4 of 5

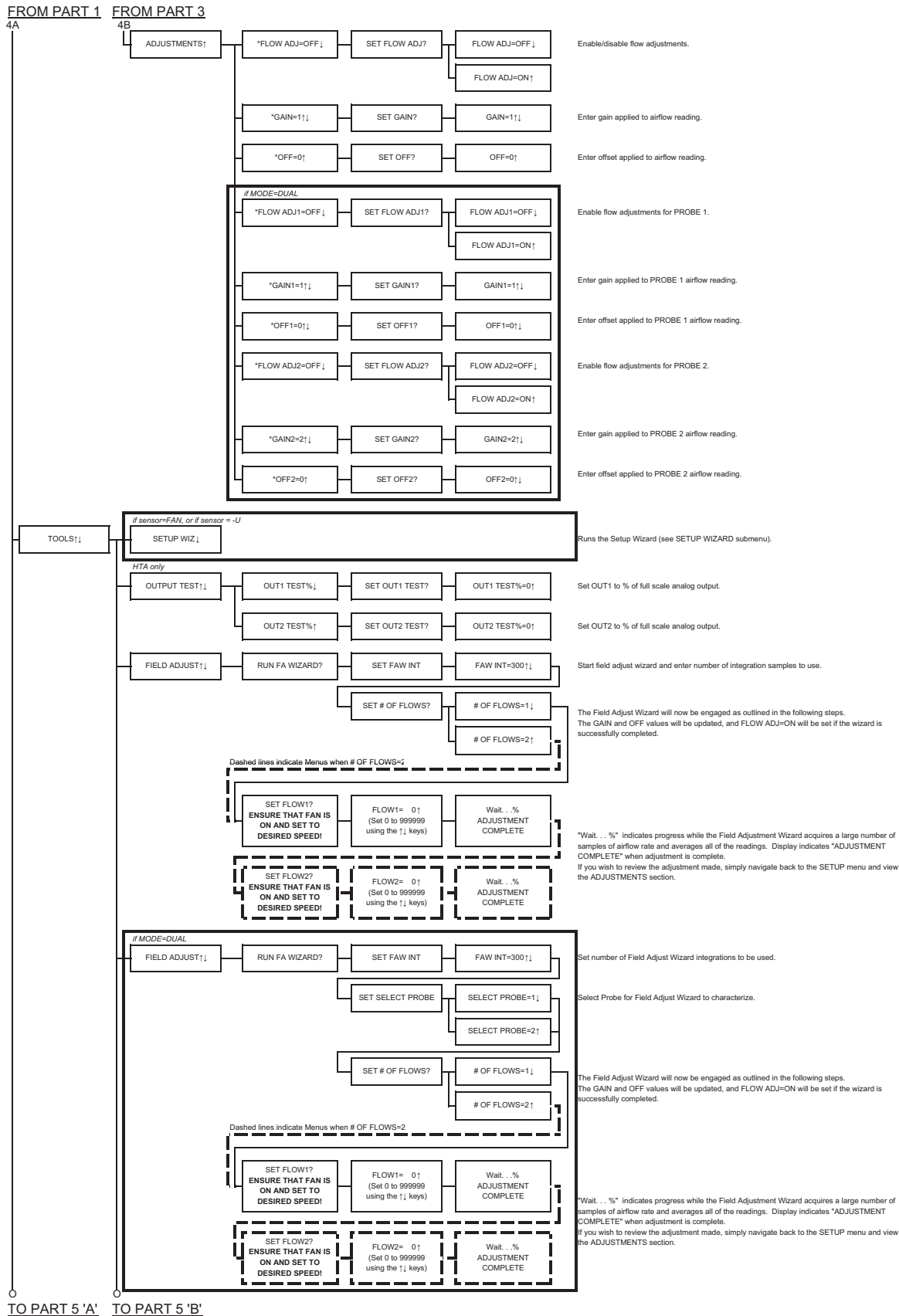

TM_HTX104_R6A

HTx104 Setup Menu Options

Part 5 of 5

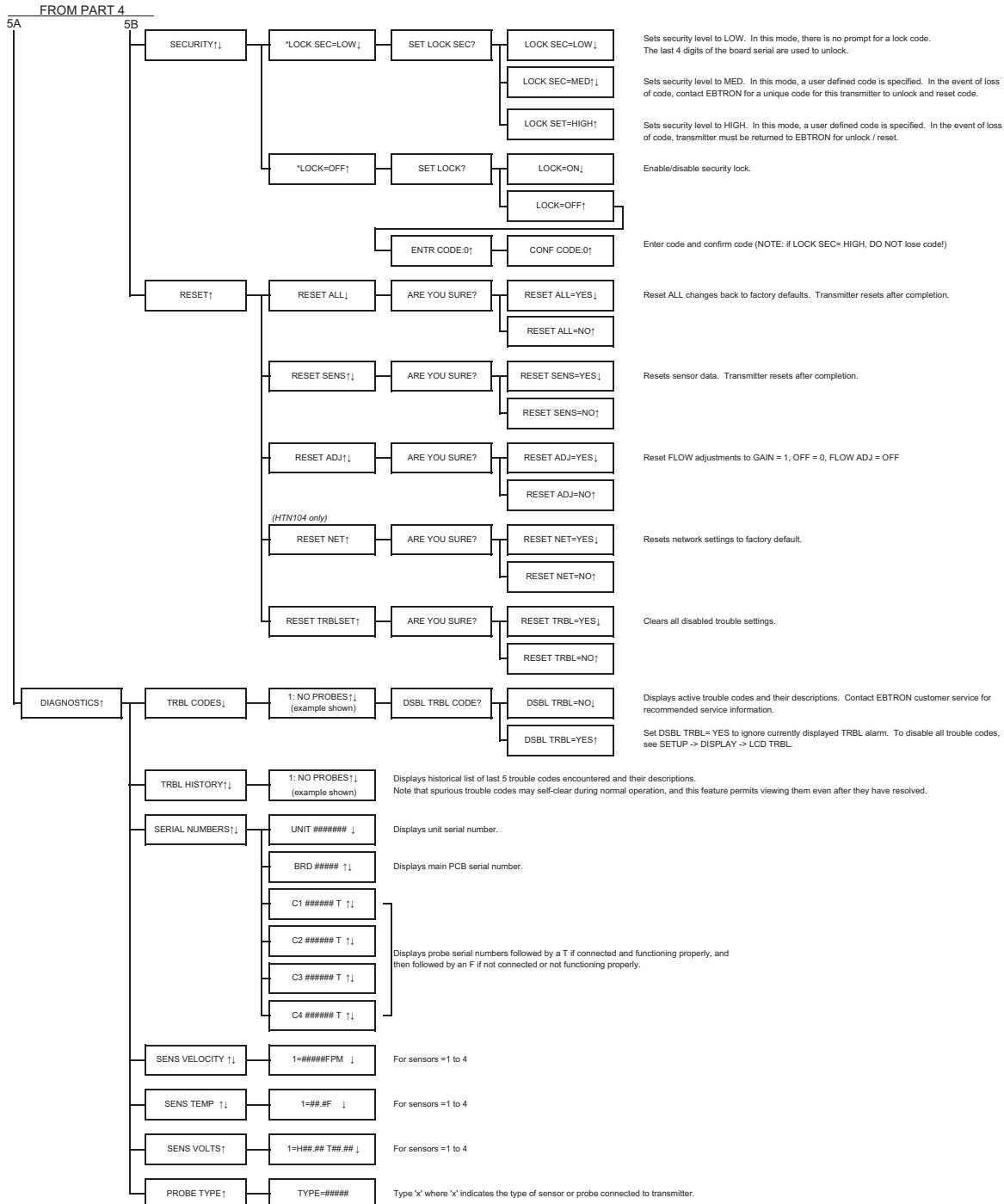

TM HTx104_R6A

APPENDIX B - HTx104 WIRING DIAGRAMS

HTA104 Wiring Diagram

HTA104 Analog Transmitter with -P, -F, -T or -U Probes

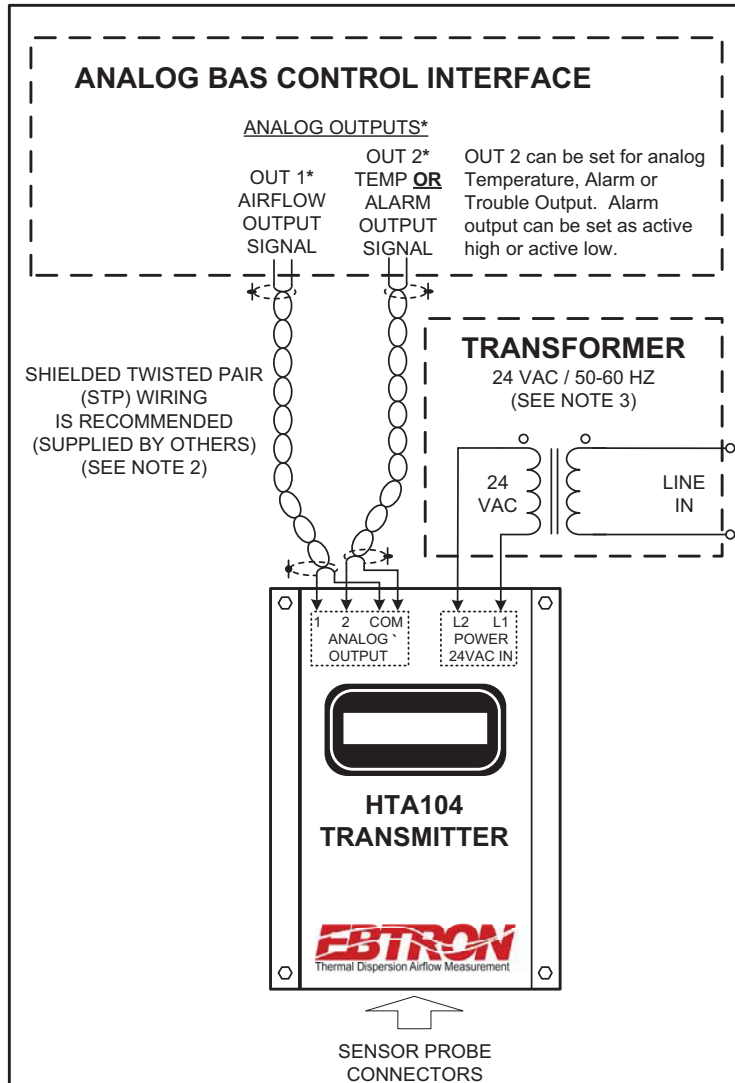

NOTES:

1. OUT 2 CAN BE SET AS TEMPERATURE OR AS AN ALARM. ALARM CAN BE SET AS ACTIVE HIGH OR ACTIVE LOW.
2. CONNECT OUTPUT SIGNAL CABLE DRAINS TO EARTH GROUND AT ONE END OF EACH CABLE ONLY.
3. ON MULTIPLE TRANSMITTER INSTALLATIONS WITH A COMMON 24VAC SOURCE, WIRE 24 VAC POWER IN-PHASE TO THE SAME TERMINALS ON ALL TRANSMITTERS (e.g.: L1 to L1, L2 to L2).

* When using HU1 probes and in DUAL mode, OUT 1 is probe 1 airflow and OUT 2 is probe 2 airflow

TM_HTX104_R6A

HTA104 Wiring Diagram

HTA104 Analog Transmitter with -U Probes in DUAL MODE Applications

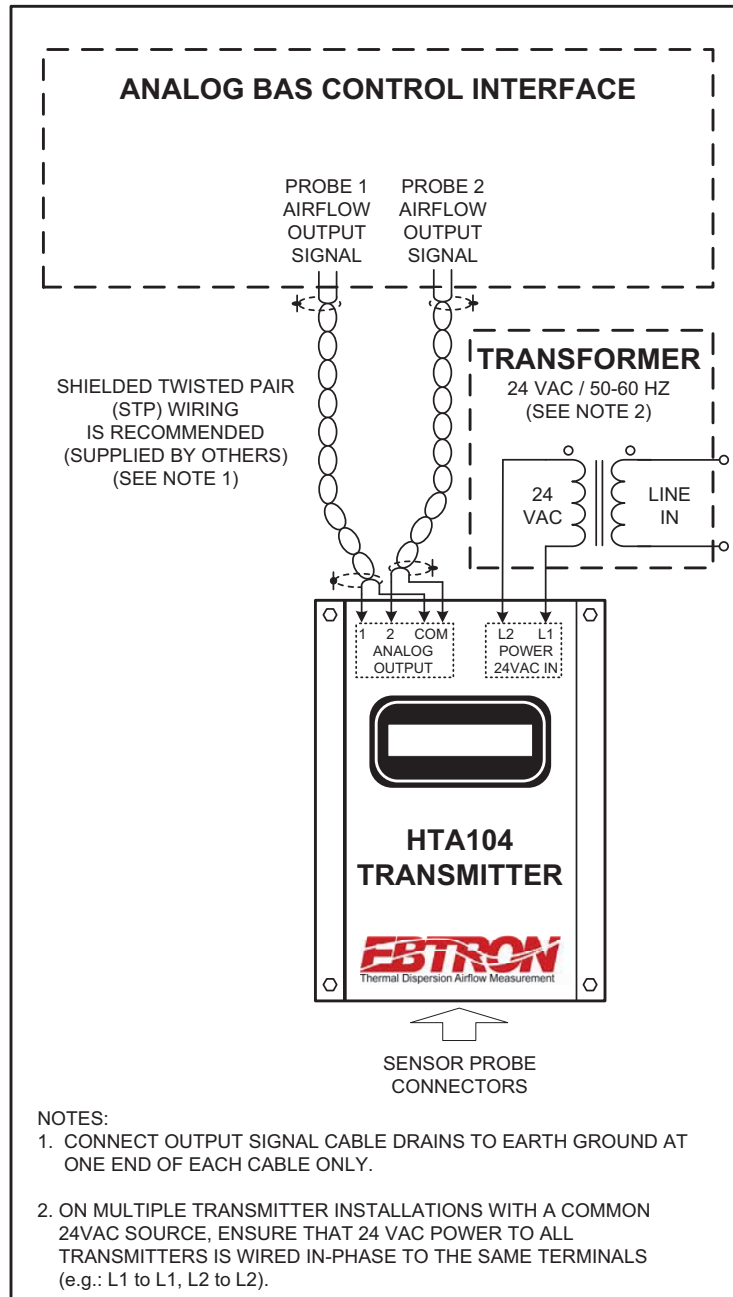

TM_HTx104_R6A

HTN104 Wiring Diagram
HT104 Analog Transmitter with -P, -F, -T or -U Probes

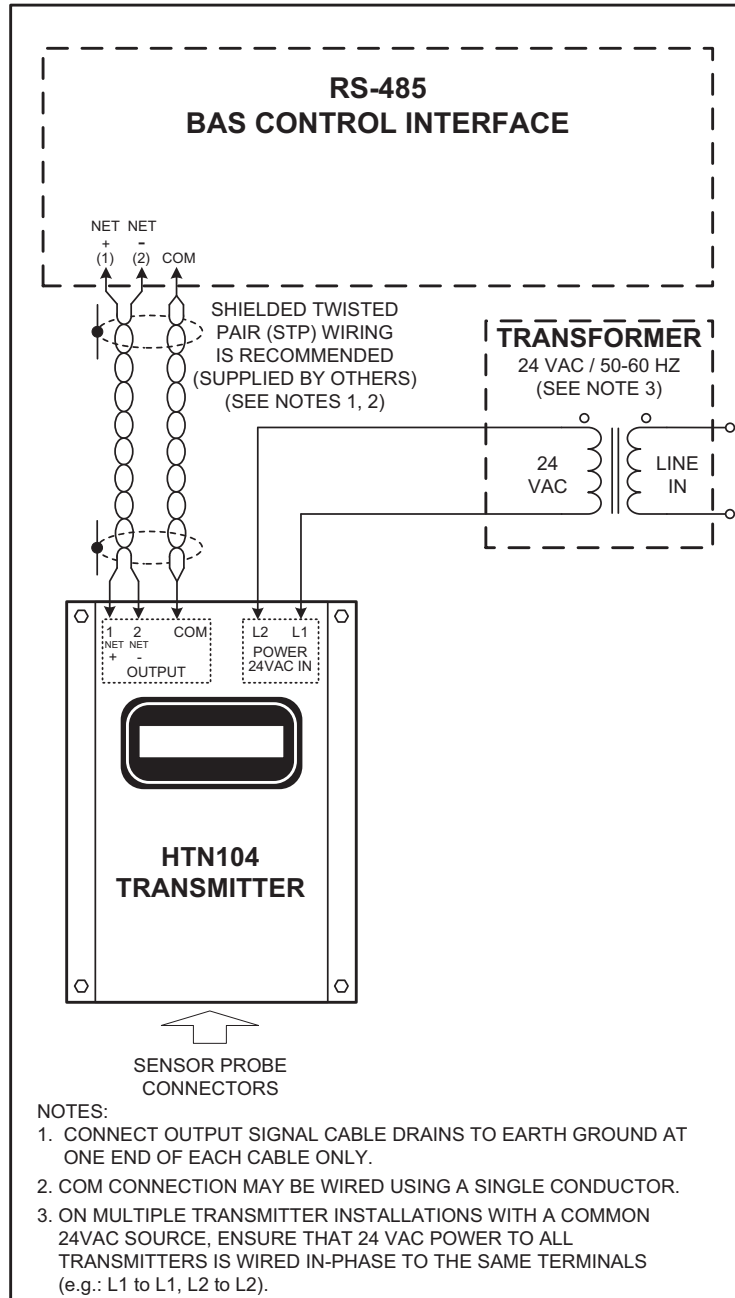

TM_HTX104_R6A