

Advantage III

Gold Series by Ebtron

Installation Guide

GTC116-B

“Plug & Play” Transmitter with Bleed Airflow Sensors,
Combination RS-485 Network Output and Dual Analog Output

Document Name: IG_GTC116-B_R1A



BACnet is a registered trademark of ASHRAE. ASHRAE does not endorse, approve or test products for compliance with ASHRAE standards. Compliance of listed products to the requirements of ASHRAE Standard 135 is the responsibility of BACnet International (B). BTL is a registered trademark of BTL.

Models GTC116 and GTM116

Part Number 930-0220B

Table of Contents

1	GTC116 TRANSMITTER INSTALLATION	4
1.1	GTC116 Mechanical Dimensions.....	4
2	GTC116 TRANSMITTER INTERIOR VIEW/FEATURES.....	5
3	GTC116 TRANSMITTER POWER AND SENSOR CONNECTIONS.....	6
3.1	Power Transformer Selection	6
3.2	Connecting Power to the Transmitter	6
3.3	Connecting Bleed Airflow Sensors to the Transmitter.....	7
4	GTC116 ANALOG OUTPUT AND NETWORK CONNECTIONS.....	8
4.1	GTC116 - ANALOG OUTPUT WIRING.....	8
4.2	GTC116 - RS-485 NETWORK WIRING CONNECTIONS	9
4.2.1	GTC116 - RS-485 Network Cable Specifications	9
4.2.2	GTC116 - Connecting to an RS-485 Network:.....	9
4.2.3	GTC116 - Setting Transmitter Termination for RS-485 Network	9
4.3	GTC116 - Transmitter Setup for RS-485 Network Operation.....	9
4.3.1	GTC116 - RS-485 Network Options and Communications Menu Settings.....	9
4.3.2	GTC116 - Setting RS-485 Network Protocol	10
4.3.3	GTC116 - Setting Transmitter Address	10
4.3.4	GTC116 - Setting Baud Rate	10
4.3.5	GTC116 - Setting Modbus Parity.....	10
4.3.6	GTC116 - Setting BACnet Device Instance Number.....	10
4.3.7	GTC116 - Resetting Communications Options to Factory Default Values	10
5	GTC116 TRANSMITTER START-UP, INITIALIZATION AND SETUP MENUS.....	12
5.1	Changing the System of Units - IP or SI Units	12
5.2	GTC116 Transmitter Calibration	12
5.3	GTC116 LCD Display Notifications.....	12
5.4	Factory Default Menu Settings for GB1 Sensor Probes	13
5.5	GTC116 Changing Factory Default Setup Menu Settings.....	14
5.5.1	Setup Menu Options.....	14
5.5.2	Selecting Airflow or Pressure Measurement Type	14
5.5.3	Selecting Actual and Standard Output Measurement Type	14
5.5.4	Output Scaling	14
5.5.5	Locking the Configuration Settings	14
5.6	GTC116 - Alarm Features	15
5.6.1	Average Alarm (AO2 ASGN=ALRM).....	15
5.6.2	Trouble Alarm (AO2 ASGN=TRBL)	15
5.6.3	No Fault (NO FAULT=HI)	15
5.6.4	Alarm Indications	15
5.6.5	Low Alarm - "LO ALRM= ON"	15
5.6.6	High Alarm - "HI ALRM= ON"	15
5.6.7	Trouble Alarm - "AO2 ASGN=TRBL"	15
5.7	GTC116 - Analog Output Type Selection and Setup	16
5.7.1	GTC116 - Converting Analog Output Signal Values to Airflow and Temperature	16
5.7.2	GTC116 - AO1/AO2 OUTPUT TEST - Sending a Test Output Signal to the Host Control System	16
5.8	Viewing Sensor Data	17
5.8.1	Viewing Sensor Data on the Local LCD Display	17
5.8.2	Viewing Sensor Data via BACnet , Modbus networks or via EB-Link Reader	17
5.8.3	Sensor Addressing.....	17
6	SETUP MENUS.....	17
7	WIRING DIAGRAM.....	17
	APPENDIX A - ADVANTAGE 3 - BLEED SENSOR SETUP MENUS.....	18
	APPENDIX B - GTC116 WIRING DIAGRAM	18

List of Figures

Figure 1. GTC116 Mechanical Dimensions	4
Figure 2. GTC116 Transmitter Interior View/Features	5
Figure 3. Connecting Power to the Transmitter	6
Figure 4. Type B Transmitter Connector Panel Detail	7
Figure 5. Connector Detail	7
Figure 6. GTC116 Combination Analog/RS-485 Transmitter Interior Detail	8

List of Tables

Table 1. GTC116 Power Transformer Selection Guide	6
Table 2. GTC116-B BACnet Objects List	11
Table 3. GTC116-B Modbus Register Map	11
Table 4. Standard “IP” and “SI” Menu Units Abbreviations	12
Table 5. Factory Default Menu Settings	13
Table 6. GTC116 Alarm Types and Notifications	15
Table 7. GTC116 Converting Analog Output Values to Airflow/Temperature.....	16

1 GTC116 TRANSMITTER INSTALLATION

The GTC116 transmitter is designed for use in an environment between -20° F to 120° F (-28.8° C to 48.8° C) where it will not be exposed to rain or snow. Install transmitter upright and in a field accessible location. The enclosure accepts 1/2 in. (12.7 mm) electrical fittings for signal and power wiring at both sides at the top of the enclosure.

Locate the transmitter so that the connecting cables from all of the bleed sensors will reach the receptacles on the bottom of the transmitter enclosure.

- ⚠ In locations exposed to direct rain and/or snow, the transmitter must be enclosed in a NEMA4 enclosure.
- ⚠ Leave unobstructed space of at least 9 in. (228.6 mm) above, 2 in. (50.8 mm) to each side and 3.5 in. (88.9 mm) below the transmitter to allow for cover removal, sensor connections and heat dissipation.
- ⚠ Locate the transmitter in a location that can be reached by all connecting cables from the bleed sensors.
- ⚠ Do not drill into the transmitter enclosure since metal shavings could damage the electronics.

1.1 GTC116 Mechanical Dimensions

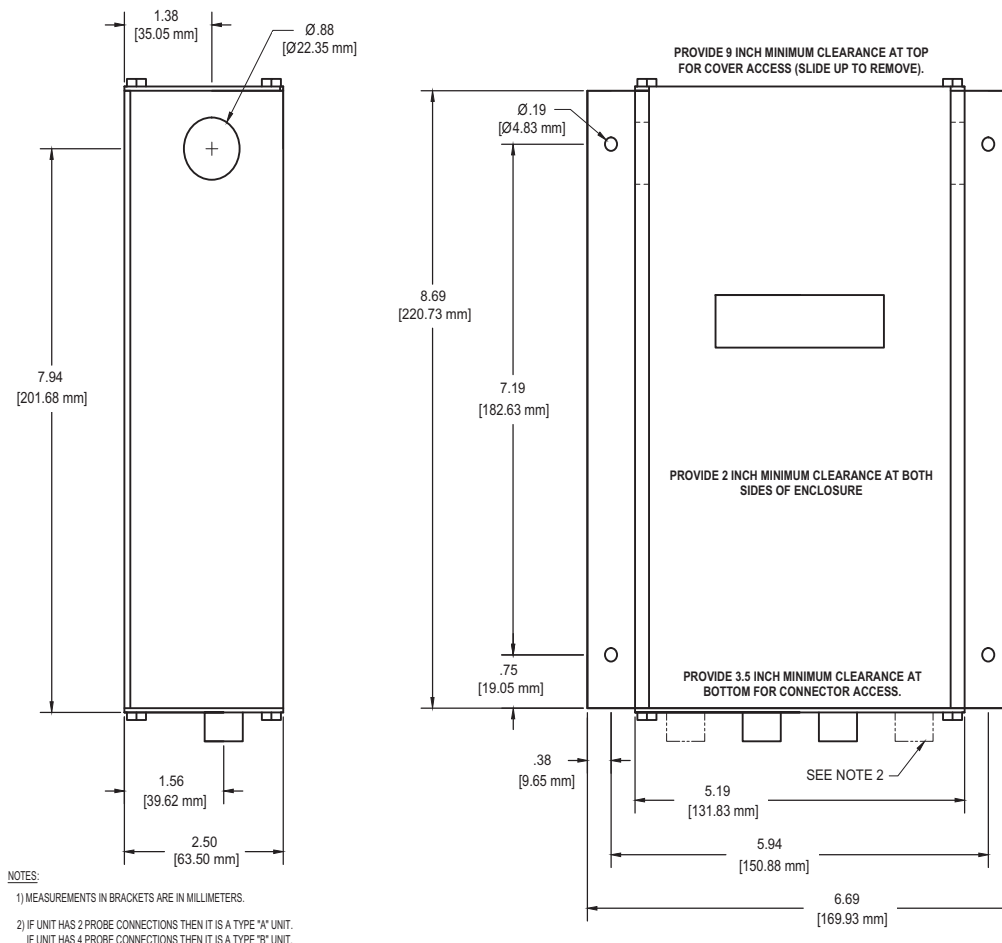

Figure 1. GTC116 Mechanical Dimensions

2 GTC116 TRANSMITTER INTERIOR VIEW/FEATURES

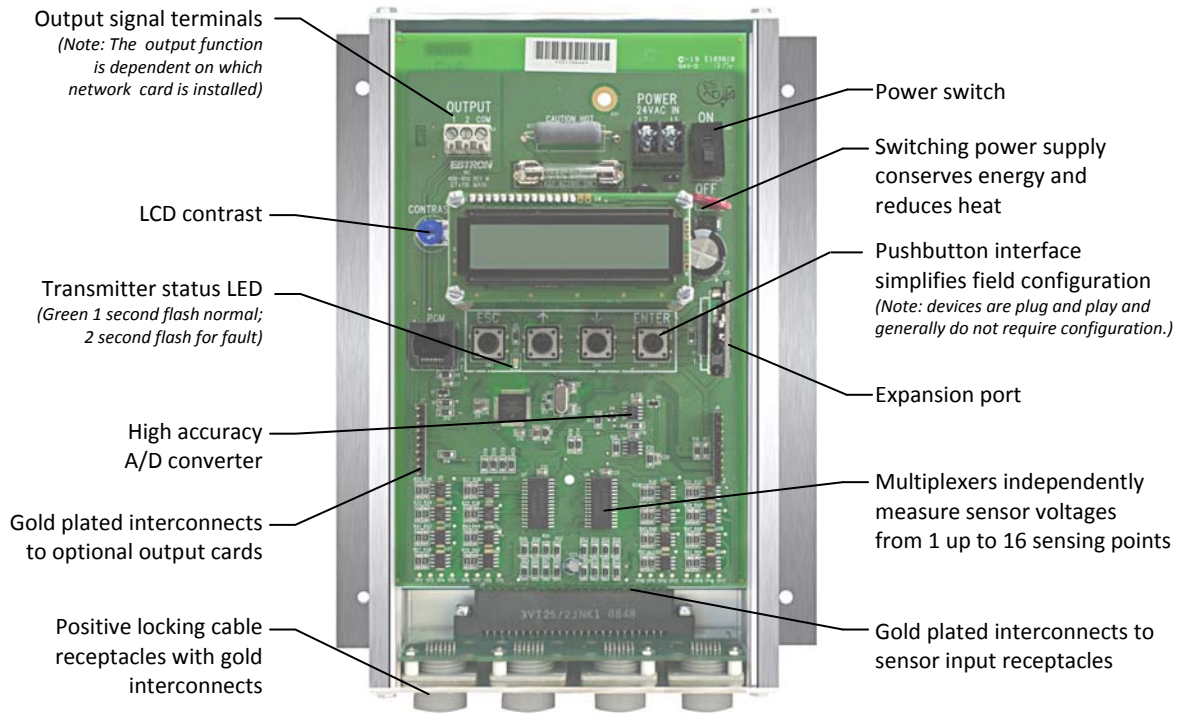

Figure 2. GTC116 Transmitter Interior View/Features

3 GTC116 TRANSMITTER POWER AND SENSOR CONNECTIONS

3.1 Power Transformer Selection

Select a 24 VAC transformer based on the maximum power requirements indicated on the transmitter label (16 VA) or from the table below. The operating supply voltage (transmitter power “ON” with all bleed sensors connected) should not be less than 22.8 VAC or greater than 26.4 VAC.

Table 1. GTC116 Power Transformer Selection Guide

Total Sensors	Minimum VA Req.	Total Sensors	Minimum VA Req.
1	12	5	14
2	13	6	15
3	13	7	15
4	14	8	16

3.2 Connecting Power to the Transmitter

Connect 24 VAC power to the large, two position power input terminal labeled “POWER” on the upper right hand side of the main circuit board (Figure 3). Since the output signals are isolated from the power supply, it is not necessary to provide an isolated (secondary not grounded) power source.

 Multiple GTC116 transmitters wired to a single transformer must be wired “in-phase” (L1 to L1, L2 to L2).

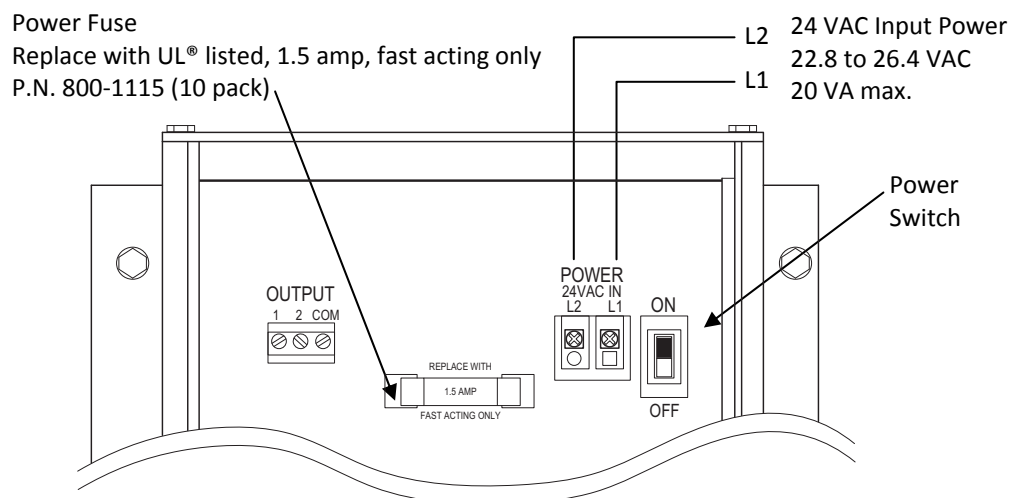





Figure 3. Connecting Power to the Transmitter

3.3 Connecting Bleed Airflow Sensors to the Transmitter

After installing the sensors and transmitter, connect each of the bleed sensor cable plugs to the circular receptacles located at the bottom of the GTC116 transmitter enclosure. Bleed sensors are “Plug and Play” and do not have to be connected to a specific receptacle on the transmitter unless traverse data is desired (see note below). Transmitters accept only GP1 and GB1 sensors.

-  Provide a “drip loop” at the transmitter if there will be the potential for water runoff or condensation along the bleed sensor cable(s).
-  Bleed sensor cable plugs are “keyed” as shown below. Line up plug with receptacle and push straight on to receptacle.
-  DO NOT TWIST. Squeeze cable plug “ribs” towards receptacle when removing. Forcing the cable plug in or out of the receptacle will damage the connectors and void warranty.
-  When traverse data is desired (especially when using the EB-Link Reader), bleed sensors should be installed and connected to the transmitter using the mounting convention specified in the separate GP1/GB1 sensor probe Installation Guide. Proper installation simplifies sensor location decoding during data analysis.

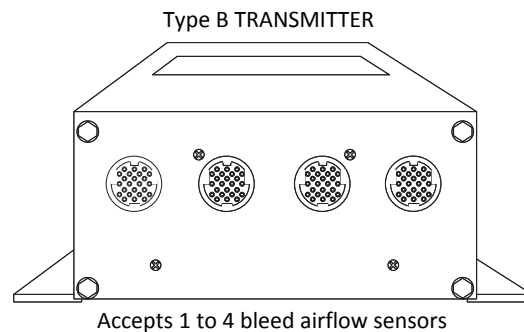
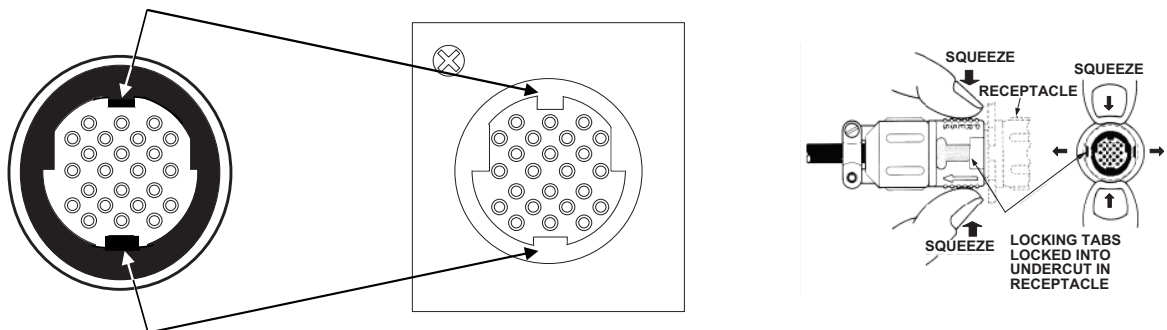

Figure 4. Type B Transmitter Connector Panel Detail



Squeeze and then pull to remove
DO NOT TWIST!

Figure 5. Connector Detail

4 GTC116 ANALOG OUTPUT AND NETWORK CONNECTIONS

This section contains analog and network output wiring instructions for the GTC116 transmitter with RS-485 and Dual Analog outputs.

4.1 GTC116 - ANALOG OUTPUT WIRING

Analog output connections are made at the top left of the transmitter main circuit board OUTPUT connector as shown in Figure 6. Independent linear analog outputs are provided for airflow or equivalent differential pressure at OUTPUT terminal 1, and for temperature (or alarm) at OUTPUT terminal 2, each with over voltage and over current protection. Airflow and temperature outputs are field selectable for either 0-5/0-10VDC or 4-20 mA. The OUTPUT terminal 2 can be assigned as an Alarm output to provide an active high, active low or trouble alarm output. Outputs are galvanically isolated from the main power supply to permit simple integration with virtually all building automation systems.



When configured for 4-20mA output, the GTC116 is a “4-wire” device. The host controls shall not provide any excitation voltage to the output of the GTC116.

For the analog outputs, shielded cable is recommended. To wire the analog outputs, slide the cover plate up and off of the enclosure. Ensure that the power switch is in the “OFF” position. Connect signal wires for airflow rate or equivalent differential pressure and temperature (or alarm) to the small, three position output terminal labeled “OUTPUT” on the upper left hand side of the main circuit board as shown in Figure 6.

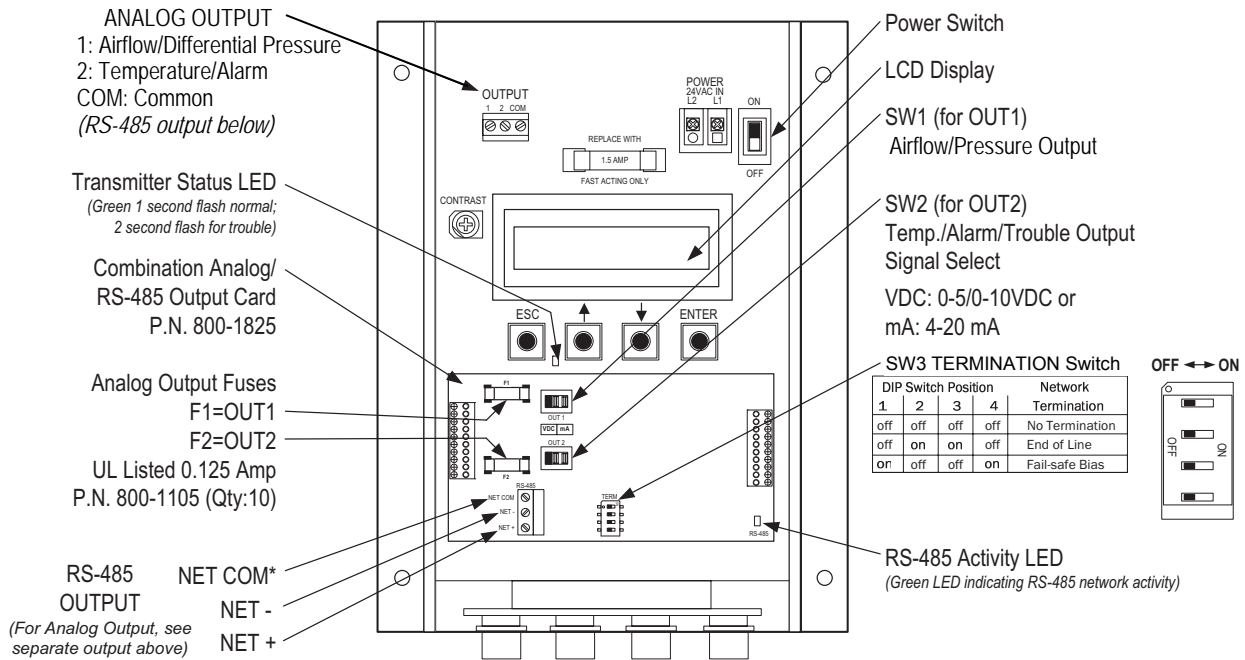

*CAUTION



The common for the ANALOG and the RS-485 outputs must be at the same potential. For ISOLATED RS-485 output, COM connection MUST BE CONNECTED to network common. For NON-ISOLATED output, COM connection MUST BE CONNECTED to the common ground that other network devices are using (typically the ground side of the 24VAC supply - L2 of the POWER terminals). Refer to RS-485 Network Wiring Connections paragraph for additional detail.

Figure 6. GTC116 Combination Analog/RS-485 Transmitter Interior Detail

a measurable difference!

4.2 GTC116 - RS-485 NETWORK WIRING CONNECTIONS

4.2.1 GTC116 - RS-485 Network Cable Specifications

The RS-485 network cable shall be shielded twisted pair with a characteristic impedance of 100 to 130 ohms. Distributed capacitance between conductors shall be less than 100 pF per meter. Distributed capacitance between conductors and shield shall be less than 200 pF per meter. The maximum recommended length of a network segment is 1200 meters with AWG 18 cable.

4.2.2 GTC116 - Connecting to an RS-485 Network:

Connect the NET+, NET- and COM terminals with shielded twisted pair cable meeting the specifications defined in the previous paragraph (typically using two pairs, with one wire not used; one pair for +/- and both wires in other pair for COM when using 2-pair cable). The connection to the network must be made in a "daisy chain" configuration. "T" connections and stubs are NOT permitted. The shield should be terminated at one end on the network only.

***CAUTION**



For ISOLATED output, the COM connection MUST BE CONNECTED to the network common for proper operation. In addition, when the Analog Output is concurrently used with the RS-485 Output, the Common connection for both Analog and RS-485 Outputs must be at the same potential.



For NON-ISOLATED output, the COM connection MUST BE CONNECTED to the common ground that is used by the other network devices (typically the ground side of the 24VAC supply; terminal L2 at the POWER connector block in Figure 6). In addition, when the Analog Output is concurrently used with the RS-485 Output, the Common connection for both Analog and RS-485 Outputs must be at the same potential.

4.2.3 GTC116 - Setting Transmitter Termination for RS-485 Network

The GTC116 is shipped with the Termination switch set for No termination, which is the recommended setting for devices installed on the network bus anywhere EXCEPT at the ends of the bus/segment. EBTRON recommends the following termination strategy for devices connected at the ends of the network bus/segment:

When the transmitter is at one end of the network, it should be terminated with "End of Line" (or 120 ohm standard) termination, and the device at the other end should be terminated with "Fail Safe Bias" termination. This method provides proper network termination and ensures that the bus is in a known state during idle-line conditions (when no devices are driving the bus). EBTRON GTC116 transmitters include three termination options for "End of Line" (standard 120 ohm) and "Fail-safe Bias" (recommended at one end of the bus) or for "No Termination". Termination is selected by setting TERMINATION DIP switch SW3 as shown below.



Check the network/network segment to ensure that only one device is terminated with either method. If multiple devices are terminated as described above, network segment operation will be adversely affected.

4.3 GTC116 - Transmitter Setup for RS-485 Network Operation

For RS-485 operation, network connections are made on the GTC116 Combination board as shown in Figure 6, and set up is as follows. Network protocol, MS/TP address, device instance number and baud rate options are all selected with- in the NETWORK section of SETUP menu shown in Appendix A.

NOTE:

Prior to power up, network wiring and termination switch must be set as shown in Figure 6.

4.3.1 GTC116 - RS-485 Network Options and Communications Menu Settings

The transmitter is shipped from the factory with the protocol set for BACnet MS/TP Master, address 2, MS/TP Device ID 2, Baud rate of 76,800 and no termination. Initial RS-485 communications settings are accomplished within the GTC116 NETWORK sub menu shown in Appendix A. Termination is set up by the TERM DIP switch SW3 located on the Combination card shown in Figure 6.

a measurable difference!

4.3.2 GTC116 - Setting RS-485 Network Protocol

Transmitter protocol can be set for MS/TP or MODBUS as shown in the NETWORK submenu (Appendix A).

Tables 2 and 3 list the specific features of each protocol.

4.3.3 GTC116 - Setting Transmitter Address

The GTC116 is factory set to an address of 2. Each transmitter must be assigned a unique address between 0 and 127 for BACnet or 1 and 247 for Modbus prior to connecting it to the network. Set the address in the NETWORK submenu (Appendix A).

4.3.4 GTC116 - Setting Baud Rate

The GTC116 transmitter default baud rate for MS/TP is 76,800 and for MODBUS is 19,200. Baud rate can be configured in the NETWORK sub menu (Appendix A).

4.3.5 GTC116 - Setting Modbus Parity

When using Modbus communications protocol, Parity can be changed in the NETWORK submenu. Parity can be set for Even (default), Odd, None 1 (with 1 stop bit), or None 2 (with 2 stop bits).

4.3.6 GTC116 - Setting BACnet Device Instance Number

When using BACnet communications protocol, the factory default Device Instance Number is 2. Device Instance Number can be set as shown in the NETWORK submenu. Device Instance Number can also be changed to any number between 0 and 4,194,302 by writing to the Device Object's Object Identifier Property over the network.

4.3.7 GTC116 - Resetting Communications Options to Factory Default Values

Communications options can be reset to factory default values (asterisk * values using the GTC116 RESET NET menu option.

Table 2. GTC116-B BACnet Objects List

Analog Inputs

Type, ID	Name	Default Units	
Device	GTC116		
AI, 1	Average Flow	CFM	
AI, 2	Average Pressure	iWG	
AI, 2	Average Temperature	°F	
AI, 3	Alarm Status		0: No alarm, 1: High Alarm, 2: Low Alarm, 3: Both

Analog Values

AV, 1	Area	sq.ft.	
AV, 2	Traverse Data Status		0=Disabled, 1=Flow, 2=Temp, 3=Both
AV, 3	Flow Traverse	FPM	
↕	↕	↕	
AV, 18	Flow Traverse	FPM	
AV, 19	Temperature Traverse	°F	
↕	↕	↕	
AV, 34	Temperature Traverse	°F	

Notes:
 1. Flow and Temp traverse must be enabled through AV2.
 2. User Executed Services Supported:
 Subscribe COV, Read Property, Write Property,
 Device Communication Control, Who-Is.



BACnet MS/TP

Table 3. GTC116-B Modbus Register Map

Function	Address	Type	Units	Description	Range/Value
2	10001	Boolean		Trouble Status	0:OK, 1:Trbl
4	30001-30002	float	FPM	Average Airflow	-3,000 to 3,000
4	30003-30004	float	iWG	Average Pressure	-2.5 to 2.5
4	30005-30006	float	°F	Average Temperature	-20 to 160
4	30007	word		Number of Inserts	0 to 8
4	30008	word		Alarm Status	0: No alarm 1: High Alarm 2: Low Alarm 3: Both
4	30009	word		Connector C1 Sensors	0 to 8
4	30010	word		Connector C2 Sensors	0 to 8
4	30011	word		Connector C3 Sensors	0 to 4
4	30012	word		Connector C4 Sensors	0 to 4
4	30013-30020	float	FPM	Airflow Flow Traverse	-3,000 to 3,000
	30013-30014			Insert 1 Flow	
	↕			↕	
	30019-30020			Insert 4 Flow	
4	30021-30028	float	°F	Temperature Traverse	-20 to 160
	30021-30022			Insert 1 Temp	
	↕			↕	
	30027-30028			Insert 16 Temp	
4	30029-30030	float	Sq.Ft.	Area	0 to 100
4	300202	word		Float word order	0: high word first; 1: low word first

5 GTC116 TRANSMITTER START-UP, INITIALIZATION AND SETUP MENUS

To ensure a successful start-up, verify that the bleed sensors and transmitter are installed in accordance with *EBTRON* guidelines.



Check the physical installation, power connections and model specific signal wiring prior to turning the power switch to the “ON” position.

Move the power switch to the “ON” position. The transmitter executes a complete self-check each time the power is turned on that takes 10 seconds to complete.

5.1 Changing the System of Units - IP or SI Units

The GTC116 transmitter is provided with the system of units set to IP. To change to SI units, simultaneously press and release the “ENT” and “ESC” buttons during normal operation. “IP/SI UNITS” will be indicated on the LCD display. Refer to Appendix A SYSTEM OF UNITS MENU for details on the System of Units menu. Note that Setup Menu items are shown in IP System Of Units. When SI System of Units is selected, the units of measure abbreviations used in the menus is shown in Table 4.

Table 4. Standard “IP” and “SI” Menu Units Abbreviations

“IP” System of Units	Description	“SI” System of Units	Description
FPM	Feet per minute	MPS	Meters per second
CFM	Cubic feet per minute	LPS	Liters per second
SQF	Square feet	SQM	Square meters
F	Fahrenheit	C	Celsius
iWG	Inch of Water Gauge	PA	Pascal

5.2 GTC116 Transmitter Calibration

The GTC116 uses high quality industrial grade components and is designed for years of trouble-free operation. Periodic recalibration of the transmitter is neither required or recommended. Transmitter field calibration verifiers are available for purchase from *EBTRON* for installations requiring periodic validation of instrumentation. Contact *EBTRON* for more information.

5.3 GTC116 LCD Display Notifications

Following a brief initialization at power up, the LCD display automatically displays airflow and temperature with units of measurement in all upper case (caps) characters. The display provides additional information on system status and alarm conditions. Refer to the ALARM FEATURES section of this manual for additional detail on Alarm and Trouble Error code indications.

5.4 Factory Default Menu Settings for GB1 Sensor Probes

The GTC116 transmitter is “plug and play” and does not require setup unless a network option is selected that requires configuration. Table 5 shows the factory default settings for all compatible sensor probes.

To change the Factory Default Settings, see: CHANGING FACTORY DEFAULT SETUP MENU SETTINGS.

Table 5. Factory Default Menu Settings

Display	Description	I-P	S.I.
AIRFLOW=	Airflow measurement method, Actual or Standard.	ACT	ACT
*LCDU/M=	Airflow units of measure	AFPM	MPS
*AREA=	Free area where station is located (required for volumetric measurement)	0.00 sq.ft.	0.000 sq.meters
*AO1 SGNL=	Output 1 signal type voltage or mA (airflow)	mA	mA
*AO1 UM=	Output 1 units of measure	AFPM	AMPS
*AO1 MS=	Output 1 signal minimum scale	0 FPM	0 MPS
*AO1 FS=	Output 1 signal full scale	3,000 FPM	25 MPS
*MEAS=	Display and output measurement type (airflow or pressure)	AIRFLOW	AIRFLOW
*FLOW ADJ=	Output 1 Offset-Gain On/Off	Off	Off
*GAIN=	Output 1 Gain factor	1.000	1.000
*OFF=	Output 1 Offset factor	0.000	0.000
*AO2 SGNL=	Output 2 signal voltage or mA (temperature or alarm)	mA (see alarms)	mA (see alarms)
*AO2 MS=	Output 2 signal minimum scale	-20° F	-30° C
*AO2 FS=	Output 2 signal full scale	160° F	70° C
*LCD INTG=	Number of flow calculations to be averaged for LCD display.	100	100
*AO1 INTG=	Number of flow calculations to be averaged for AO1 output.	30	30
*EB-LK INT=	Number of flow calculations to be averaged for EB-Link readings.	300	300
*ALT=	Altitude for flow correction relative to mean sea level (0 ft).	0 ft	0 m
*AO2 ASGN =	*AO2 ASGN = TEMP Output 2 Assigned Type is Temperature	TEMP	TEMP
*SETPNT=	Alarm setpoint value. For AO2 ASGN=ALARM , operates in conjunction with TOL=value.	0	0
*TOL=	Alarm range tolerance value. For AO2 ASGN=ALARM , this setting establishes the alarm range relative to the SETPNT= value.	0	0
*NO FAULT=	Sets the AO2 normal (not alarm) output state relative to the full scale analog output selected. HI provides maximum full scale under normal conditions and minimum scale during alarm. LO provides minimum full scale under normal conditions and maximum scale during alarm.	HI	HI
*DELAY=	Time that the alarm condition must exist before alarm output is activated.	2 minutes	2 minutes
*RESET =	Set to AUTO to have alarm self-clear when alarm condition no longer exists. Set to MANUAL to require manual reset of alarm.	AUTO	AUTO

a measurable difference!

5.5 GTC116 Changing Factory Default Setup Menu Settings

5.5.1 Setup Menu Options

The GTC116 Transmitter is setup and tested at the factory to be fully operational when sensors are connected and power is applied (set the power switch to the "ON" position). Factory settings can easily be changed using the SETUP MENU by simultaneously pressing and releasing the "UP" and "DOWN" buttons while the transmitter is in its normal operating mode. Appendix A details the SETUP menus. Navigate through the SETUP menus to make changes to the transmitter configuration. The settings take effect immediately. The following are common field modifications to the factory default settings.

5.5.2 Selecting Airflow or Pressure Measurement Type

The transmitter is set from the factory to provide airflow measurement with both LCD and analog output units in FPM. If desired, the output can be set to provide pressure measurement with both LCD and analog output units in iWG by engaging the MEAS= menu item, and selecting 'PRESS'.

5.5.3 Selecting Actual and Standard Output Measurement Type

The transmitter is set from the factory to provide actual airflow measurement units (displayed as "ACFM" and "AFPM"). In this mode, airflow measurements are calculated for actual airflow conditions. If using actual airflow conditions, corrections for altitude are entered through the ALT= setting in the Setup menu. If desired, the output can be set to provide standard airflow measurement units (displayed as "SCFM" and "SFPM") which provides measurements that are corrected to standard conditions.

5.5.4 Output Scaling

EBTRON's Gold Series sensors are individually calibrated between 0 and the factory default full scale to standards traceable to the National Institute of Standards and Technology (NIST). Sensors are independent and produce "percent of reading" accuracy. Changing the full scale value does not change the accuracy of the device. Factory default analog output scaling can be changed within the SETUP menus.

5.5.5 Locking the Configuration Settings

The GTC116 transmitter configuration settings can be locked at one of three security levels within the SECURITY submenu using the LOCK SEC= item.

When LOW security level is selected (LOCK SEC=LOW) the last 4 digits of the board serial number are automatically assigned as the lock code. To see the board serial number, navigate to DIAGNOSTICS menu in SERIAL NUMBERS item.

When the MED security level is selected (LOCK SEC=MED) the user enters and confirms a security code. In the event that this code is lost/misplaced, EBTRON can provide a key that is unique to the transmitter to unlock it. Contact EBTRON customer service for this code.

When the HIGH security level is selected (LOCK SEC=HIGH) the user enters and confirms a security code. In the event that this code is lost/misplaced, the transmitter must be returned to the factory in order to unlock it.



When LOCK SEC=HIGH is selected, the user defined setting can only be changed after entering the user defined code. STORE THE LOCK CODE IN A SAFE LOCATION! For security reasons, the HIGH level lock code can only be reset by returning the transmitter to the factory.

5.6 GTC116 - Alarm Features

Analog output AO2 (OUT2) can be assigned to function as an alarm output. The AO2 alarm output can be assigned in the SETUP menu to operate as an average alarm for airflow or pressure depending on MEAS= setting (AO2 ASGN=ALRM) or as a trouble alarm (AO2 ASGN=TRBL) for monitoring the status of the transmitter and sensors. The AO2 ASGN= setting is located in the ANALOG OUT submenu of the SETUP menu. The transmitter LCD display will indicate the Alarm status for 2 seconds, and will cycle through any other alarms if multiple alarm events are active for 2 seconds each, and then display the current actual flow for 2 seconds. Detailed set up of the Alarm features is shown in the Setup menu.

5.6.1 Average Alarm (AO2 ASGN=ALRM)

AO2 output is assigned as an average airflow alarm output. Useful for applications where a low flow alarm, a high flow alarm for operation outside of a defined range (setpoint and tolerance) is required.

5.6.2 Trouble Alarm (AO2 ASGN=TRBL)

AO2 output is assigned as a transmitter trouble alarm indicating a fault within the transmitter or a sensor of the airflow measurement system. The transmitter LCD will indicate a trouble code and a brief description of the trouble. Contact EBTRON customer service for additional information or assistance with trouble codes.

5.6.3 No Fault (NO FAULT=HI)

When AO2 output is assigned as an alarm, this setting configures the normal output condition to be HI or LO relative to the full scale analog output level selected when no fault condition exists.

5.6.4 Alarm Indications

Table 6 details the alarm types, LCD indications and AO2 alarm output indications. User can select either or both of the two Average Alarms or the Trouble Alarm:

5.6.5 Low Alarm - "LO ALRM= ON"

The Low Alarm is activated when the average airflow falls below a selected set point (SETPNT=) - tolerance (TOL=) value. Once active, the alarm can be cleared when the average airflow rises above the set point - tolerance value.

5.6.6 High Alarm - "HI ALRM= ON"

The High Alarm is activated when the average airflow rises above a selected set point (SETPNT=) + tolerance (TOL=) value. Once active, the alarm can be cleared when the average airflow falls below the set point + tolerance value.

5.6.7 Trouble Alarm - "AO2 ASGN=TRBL"

The Trouble alarm provides trouble codes useful for isolating setup issues or problems within the transmitter or sensors. The transmitter LCD will indicate TROUBLE! regardless of whether AO2 is assigned to TRBL. The Diagnostic submenu can be engaged for the error code and a brief description of the trouble. Contact EBTRON customer service for information on troubleshooting using the Trouble error codes.

Table 6. GTC116 Alarm Types and Notifications

ALARM OUTPUT ASSIGNMENT TYPE	LOCAL LCD DISPLAY OF ALARM TYPE AND NOTIFICATION	ANALOG OUTPUT 2 ALARM INDICATION	NETWORK ALARM INDICATION
LOW ALARM (Average Alarm)	Display alternates between **LOW ALARM** (then any other alarms) and actual reading for 2 seconds each.	On alarm or trouble, OUT2 is active high (or active low) relative to the full scale maximum (or minimum) analog value as determined by the SETUP Menu "NO FAULT=" selection. Individual sensor velocities can be viewed using the Diagnostics submenu.	Alarm Status is available at BACnet Objects and Modbus Registers. Refer to BACnet Objects List and Modbus Register Map for additional detail.
HIGH ALARM (Average Alarm)	Display alternates between **HIGH ALARM** (then any other alarms) and actual reading for 2 seconds each.		
TROUBLE ! (Trouble Alarm)	Display indicates TROUBLE ! (Refer to DIAGNOSTIC menu to obtain a brief description of the error and any other alarms).		

a measurable difference!

5.7 GTC116 - Analog Output Type Selection and Setup

The analog output signal type at AO1 (OUT1, airflow) and AO2 (OUT2, temperature/alarm) can be set for mA or VDC output by setting switches SW1/SW2 (Figure 6) and by selecting the 4-20mA, 0-5 VDC or 0-10VDC ranges in the ANALOG OUT sub menu options *AO1 RNGE= / *AO2 RNGE= settings. The transmitter is shipped from the factory with SW1/SW2 and Setup menu options *AO1 RNGE= and *AO2 RNGE= set for 4-20mA.

5.7.1 GTC116 - Converting Analog Output Signal Values to Airflow and Temperature

Table 7 lists specific conversion equations for analog voltage or current output options.

5.7.2 GTC116 - AO1/AO2 OUTPUT TEST - Sending a Test Output Signal to the Host Control System

A test output signal between 0 and 100% of the full scale output (4-20 mA or 0-5VDC/0-10VDC) can be provided by the GTC116 transmitter to verify proper conversion of the output signals from the transmitter at the host control system. To set a fixed output signal for airflow and temperature, navigate to the OUTPUT TEST submenu in the TOOLS menu. OUT1 and OUT2 tests are independently accessed, and the output will maintain the % selected until the "ESC" button is pressed and normal operation resumes.

Table 7. GTC116 Converting Analog Output Values to Airflow/Temperature

When OUTPUT 1 is Configured as Airflow (FPM, MPS) or Pressure (iWG, PA):

TO CONVERT TO	ANALOG OUTPUT SCALING AND TYPE		
	0-10 VDC	0-5 VDC	4-20 mA
Airflow (FPM, MPS) or Differential Pressure (iWG, Pa)	$\text{Output Voltage}/10 * (\text{FS1} - \text{MS1}) + \text{MS1}$	$\text{Output Voltage}/5 * (\text{FS1} - \text{MS1}) + \text{MS1}$	$(\text{Output Current}-4)/16 * (\text{FS1} - \text{MS1}) + \text{MS1}$

Differential Pressure (iWG) from Airflow (FPM)	$\text{Differential Pressure (iWG)} = \text{Airflow (FPM)}^2 / (2232^2)$
Airflow (FPM) from Differential Pressure (iWG)	$\text{Airflow (FPM)} = 2232 * (\text{Differential Pressure (iWG)})^{0.5}$

When OUTPUT 2 is Configured as Temperature (°F, °C):

TO CONVERT TO	ANALOG OUTPUT SCALING AND TYPE		
	0-10 VDC	0-5 VDC	4-20 mA
Temp (°F, °C)	$\text{Output Voltage}/10 * (\text{FS2} - \text{MS2}) + \text{MS2}$	$\text{Output Voltage}/5 * (\text{FS2} - \text{MS2}) + \text{MS2}$	$(\text{Output Current} - 4)/16 * (\text{FS2} - \text{MS2}) + \text{MS2}$

NOTES:

FS1 is AO1 full scale analog output value from ANALOG OUT MENU.

FS2 is AO2 full scale analog output value from ANALOG OUT MENU.

MS1 is AO1 minimum scale analog output value from ANALOG OUT MENU.

MS2 is AO2 minimum scale analog output value from ANALOG OUT MENU.

5.8 Viewing Sensor Data

5.8.1 Viewing Sensor Data on the Local LCD Display

Airflow and temperature of individual sensors can be displayed on the local LCD display by entering the Diagnostic Menu. Simultaneously depress the up ↑ and down ↓ arrows to enter the GTC116 SETUP menu, and then navigate to the Diagnostic submenu.

5.8.2 Viewing Sensor Data via BACnet , Modbus networks or via EB-Link Reader

Airflow and temperature of individual sensors can be read across BACnet or Modbus networks, or downloaded directly to an EB-Link Reader if the infra-red *EB-Link* option has been installed. Refer to the following Sensor Addressing paragraph for the suggested probe installation configuration. Tables 2 and 3 provide BACnet objects and register addressing information for individual sensor data.

5.8.3 Sensor Addressing

The bleed sensors are addressed in order from left to right from C1 to C4 based on the connector on the transmitter. The left most connector is C1.

6 SETUP MENUS

Appendix A details the various setup menus and submenus.

7 WIRING DIAGRAM

Appendix B is the wiring diagram for the GTC116 transmitter.

APPENDIX A - ADVANTAGE 3 - BLEED SENSOR SETUP MENUS

SYSTEM OF UNITS MENU

Simultaneously depress/release ENTER + ESC keys during normal operation to select

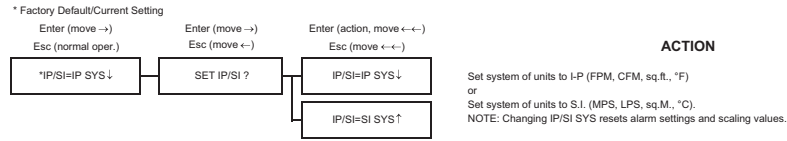

SETUP MENU

Simultaneously depress/release ↑ + ↓ keys during normal operation to select

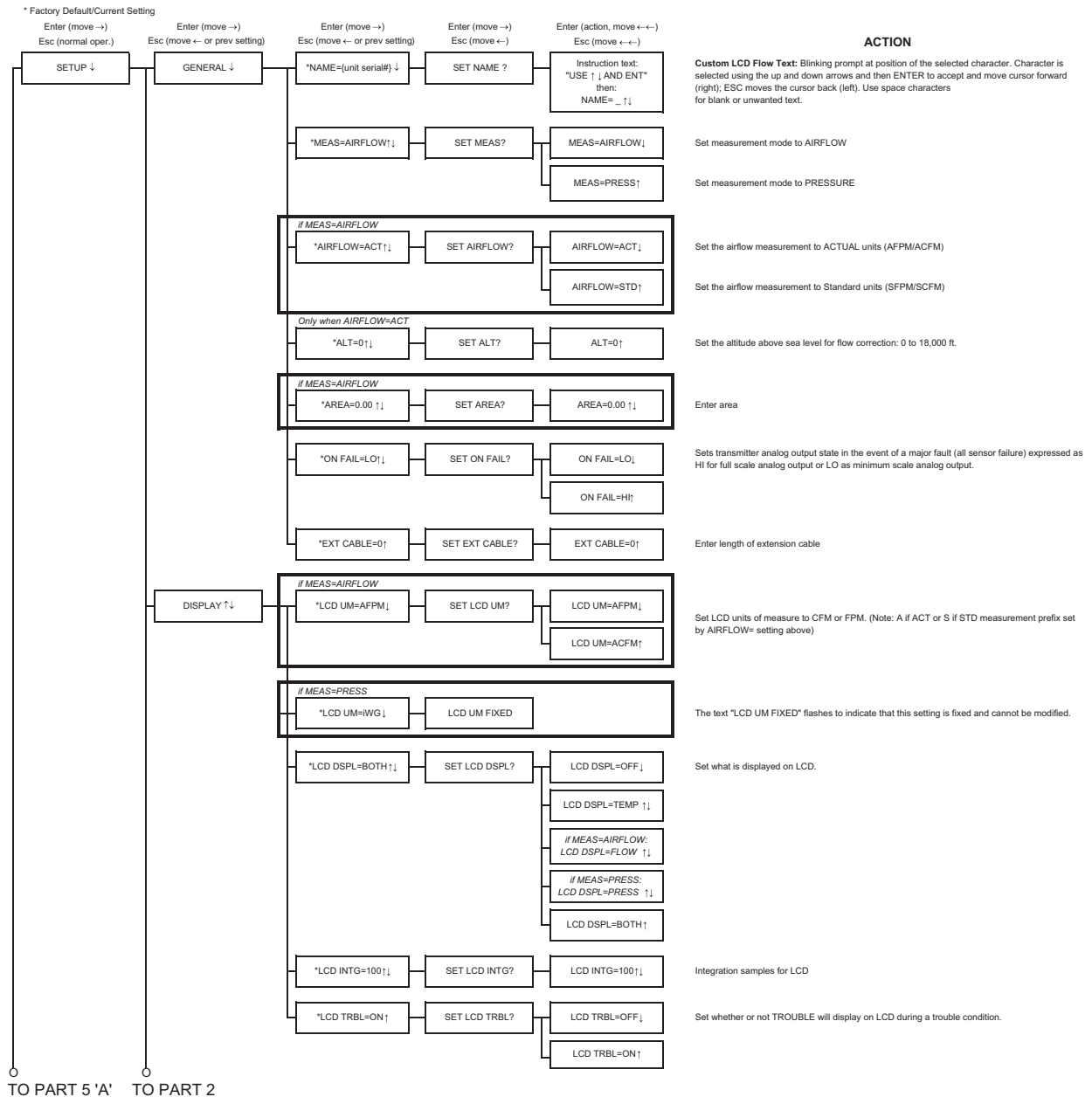

TO PART 5 'A' TO PART 2

FROM PART 1

Analog cards only

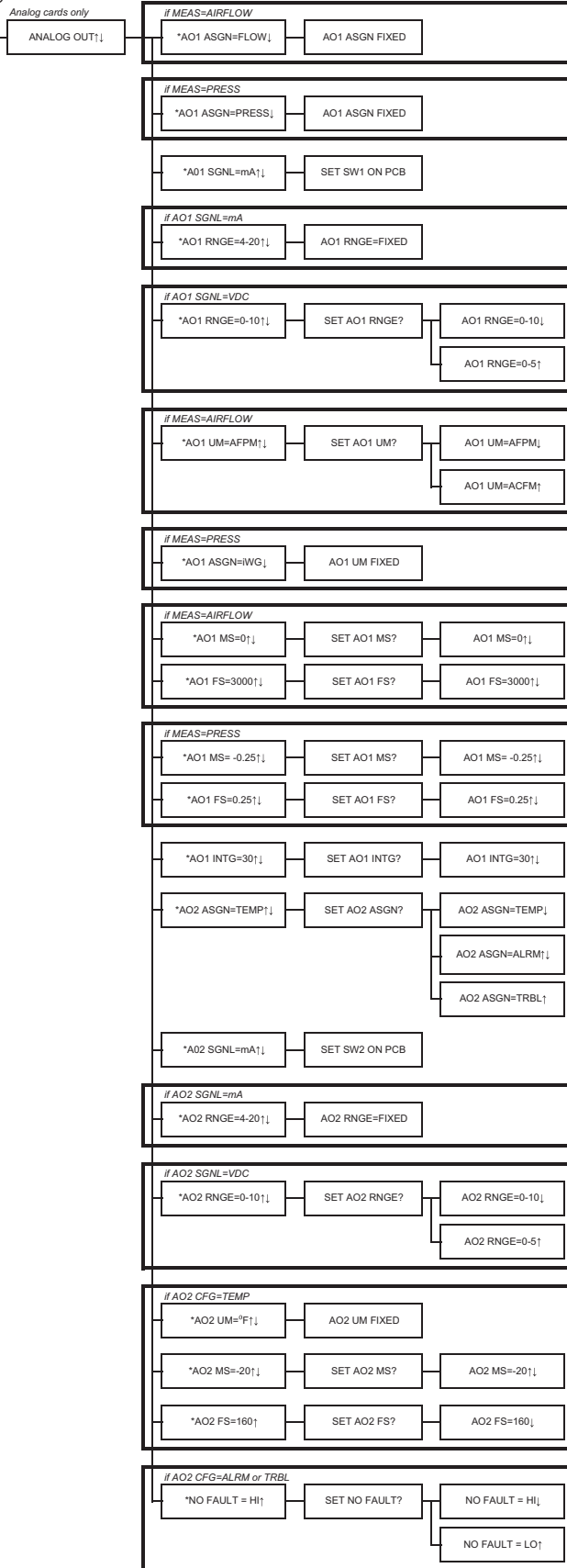

The text "AO1 ASGN FIXED" flashes to indicate this setting is fixed and cannot be modified.

The text "AO1 ASGN FIXED" flashes to indicate this setting is fixed and cannot be modified.

Display initially shows the current SW1 PCB switch setting (VDC or mA) for AO1. Pressing enter displays "SET SW1 ON PCB" prompt to confirm SW1 PCB setting.

The text "AO1 RNGE=FIXED" flashes to indicate this setting is fixed and cannot be modified.

Set analog output range (VDC) for AO1.

Set AO1 units to FPM or CFM (Note: A if ACT or S if STD measurement prefix set by AIRFLOW= setting above)

The text "AO1 UM FIXED" flashes to indicate that this setting is fixed and cannot be modified.

Set AO1 minimum scale

Set AO1 full scale

Set AO1 minimum scale

Set AO1 full scale

Integration samples. Also same as network integration.

AO2 output is assigned as temperature output.

AO2 output is assigned as an airflow alarm output. Refer to ALARM settings (part 4).

AO2 output is assigned as a transmitter trouble alarm indicating that a sensor or transmitter fault has occurred.

Display initially shows the current SW2 PCB switch setting (VDC or mA) for AO2. Pressing enter displays "SET SW2 ON PCB" prompt to confirm SW2 PCB setting.

The text "AO2 RNGE=FIXED" flashes to indicate this setting is fixed and cannot be modified.

Set analog output range (VDC) for AO2.

The text "AO2 UM FIXED" flashes to indicate this setting is fixed and cannot be modified.

Set AO2 minimum scale

Set AO2 full scale

Sets AO2 alarm/trouble output state when no fault condition is present, expressed as HI (full scale analog output) or LO (minimum scale analog output).

TO PART 3

FROM PART 2

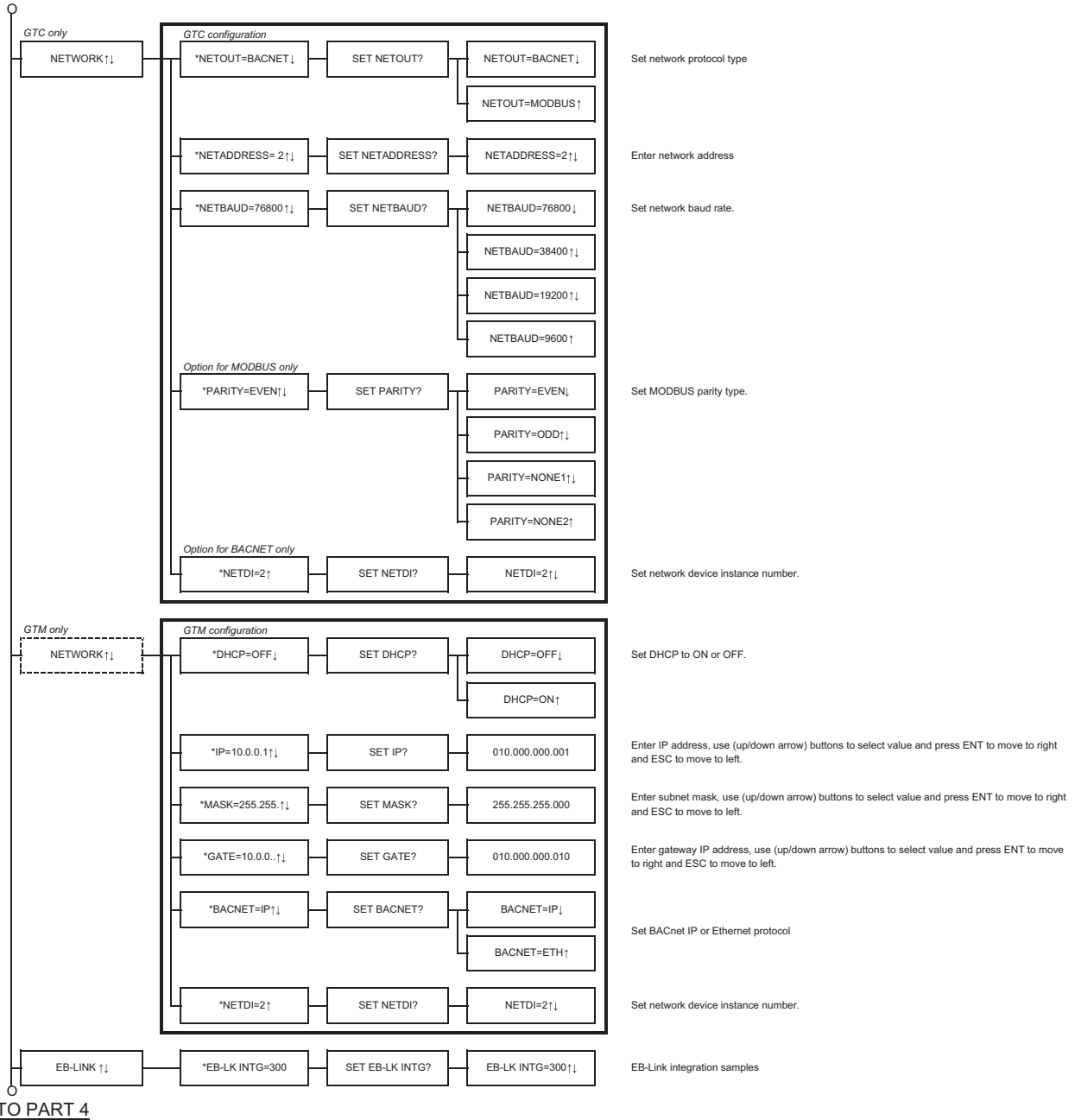

FROM PART 3

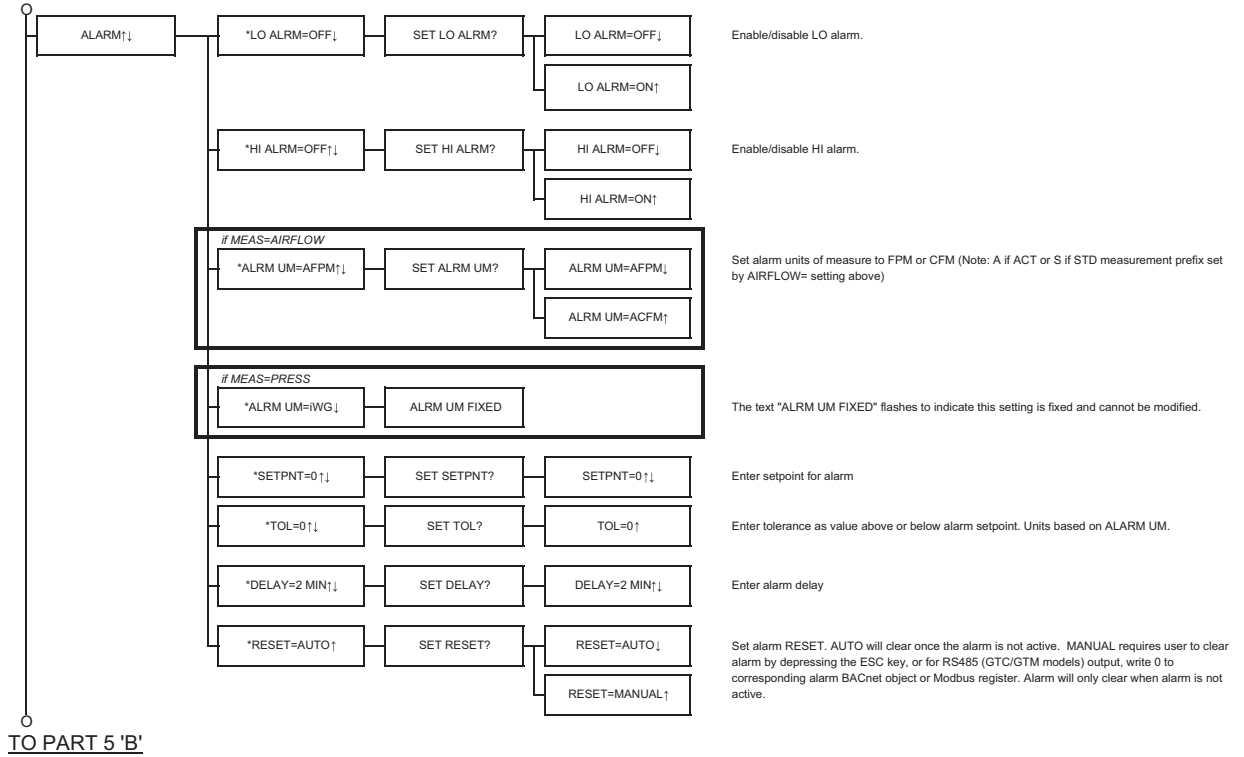

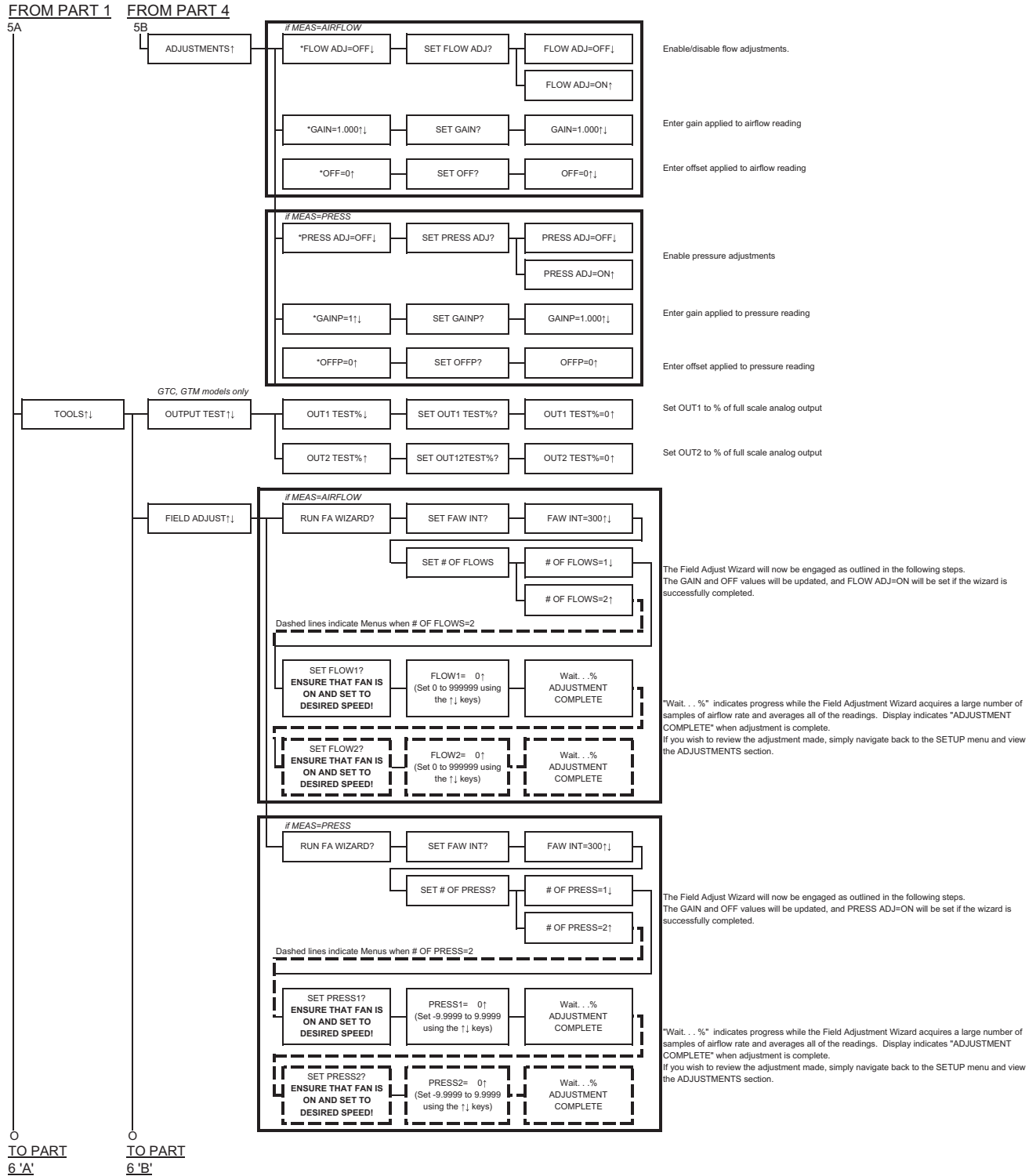

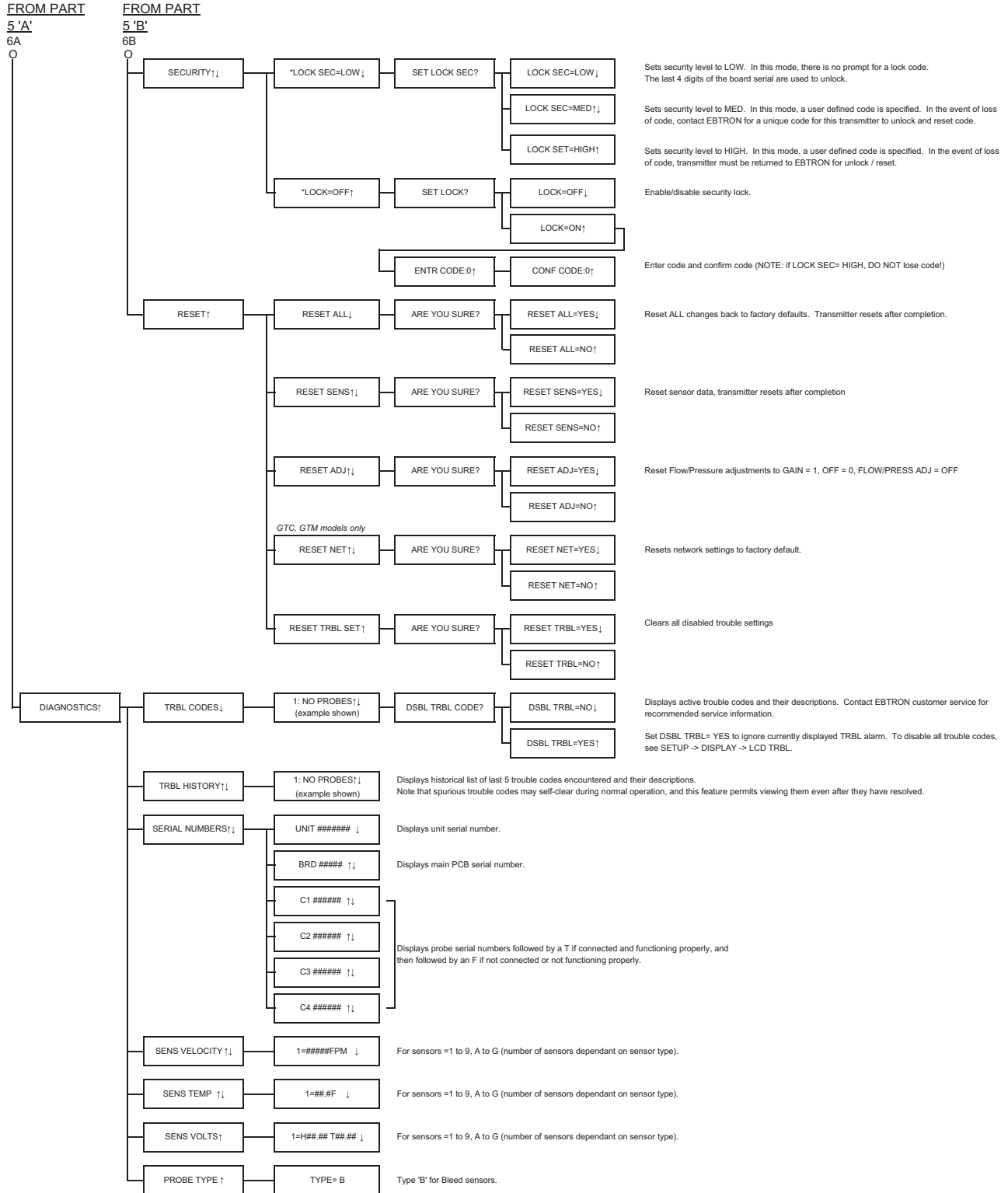

APPENDIX B - GTC116 WIRING DIAGRAM

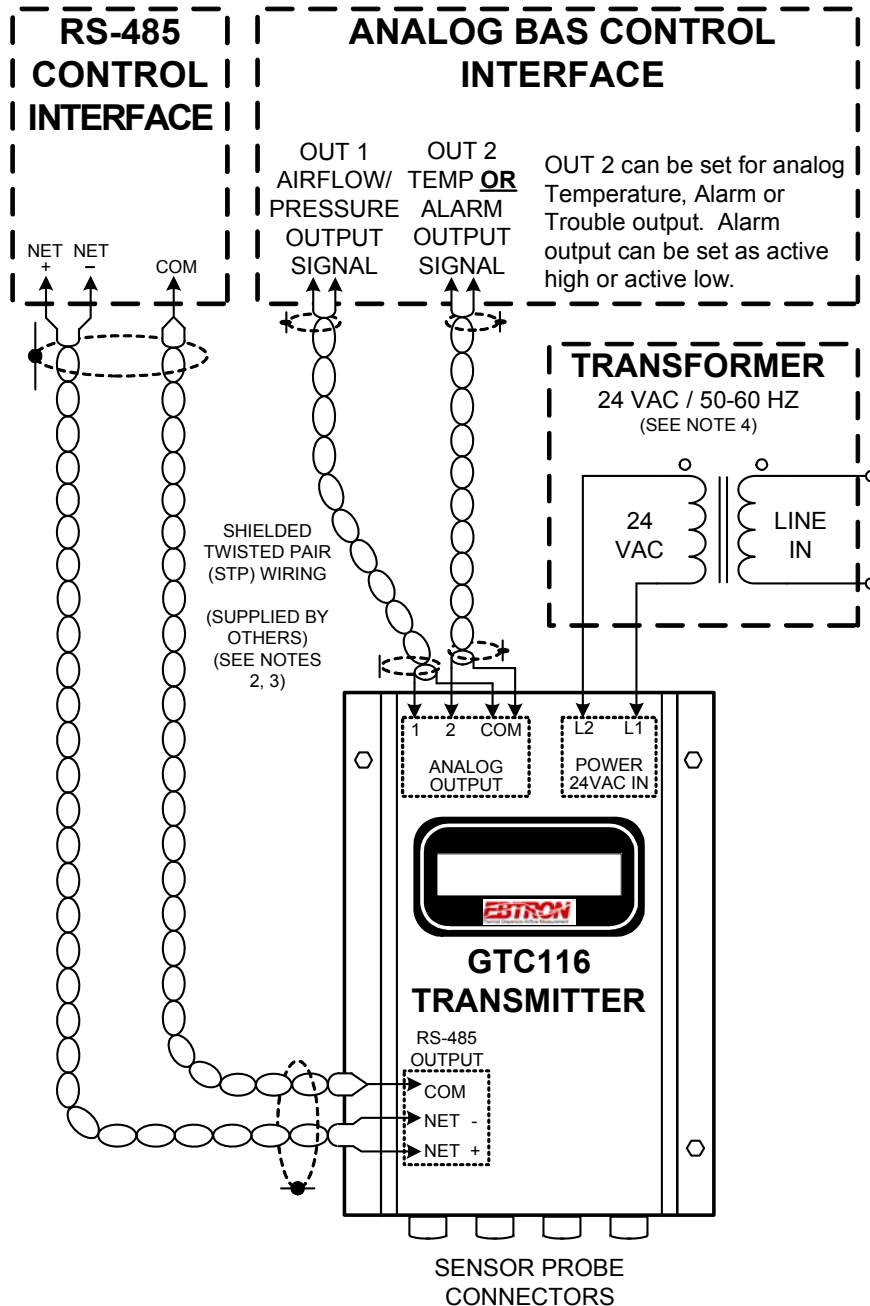

NOTES:

1. OUTPUT 2 CAN BE SET AS TEMPERATURE OR AS AN ALARM. ALARM CAN BE SET AS ACTIVE HIGH OR ACTIVE LOW.
2. CONNECT OUTPUT SIGNAL CABLE DRAINS TO EARTH GROUND AT ONE END OF EACH CABLE ONLY.
3. RS-485 COM CONNECTION MAY USE A SINGLE CONDUCTOR.
4. ON MULTIPLE TRANSMITTER INSTALLATIONS WITH A COMMON 24VAC SOURCE, WIRE 24 VAC POWER IN-PHASE TO THE SAME TERMINALS ON ALL TRANSMITTERS (e.g.: L1 to L1, L2 to L2).