

DEPENDABLE
Plug & Play Smart Sensors

Repeatable
ACCURATE



QUALITY & RELIABILITY

TAMCO® and EBTRON® are known for unsurpassed quality and reliability. This partnership joins the two premier manufacturers and brings together their respective fields of expertise to create a single, premium package that is easy to specify, purchase and install.

TURN-KEY SOLUTION

This TAMCO/EBTRON solution combines a premium airflow measuring station with a quality air-foil damper in a laboratory-tested assembly that takes the guesswork out of airflow measurement.

The unique design reduces turbulence and pressure losses associated with typical sheet metal, sleeved construction. The AIR-IQ package is ideal for:

- Direct measurement of outside airflow rates.
- Return airflow measurement on floor-to-floor systems for building pressurization.
- Return airflow measurement, directly on an air handler.
- AHU return & bypass flow measurement

FLEXIBILITY

The TAMCO/EBTRON AIR-IQ package combines EBTRON's Gold Series GTx116-PC high-performance airflow measurement technology with any TAMCO Series damper, providing unprecedented flexibility in airflow control. Whether the application is intake, exhaust, severe cold, or salt spray, there is a TAMCO®/EBTRON AIR-IQ solution.

ACCURACY & REPEATABILITY

EBTRON's field-proven thermal dispersion technology ensures accurate and repeatable airflow measurement over the entire range of airflow rates and temperatures required by today's high-performance buildings. Up to 16 individual sensor nodes are factory calibrated at sixteen airflow rates between 0 and 5,000 FPM to NIST traceable standards in EBTRON's state-of-the-art calibration facility.

MAINTENANCE-FREE PERFORMANCE

TAMCO's aluminum damper construction provides a prolonged and rust-free operational life. All damper components are designed to provide optimal and completely maintenance-free performance. TAMCO's slip-proof linkage components keep blades aligned as per factory adjustment. The hexagon design feature of the linkage and pivot elements allows for flat-on-flat press fits, eliminating play and wear. TAMCO's Dual Bearing System eliminates action between metal-to-metal and metal-to-plastic riding surfaces. Bearings never require additional lubrication and have a service life of 20 years plus.

EBTRON's thermal dispersion technology uses stable bead-in-glass thermistor probes and a high-performance, microprocessor-based transmitter. Performance is percent of reading and no additional transmitters or transducers are required to interface with your building automation system (BAS). Over 27 years of experience go into every airflow measuring device. EBTRON airflow sensors do not require periodic calibration or adjustment in most HVAC environments.

INTELLIGENT DESIGN



A - TAMCO Damper Assembly



B - TAMCO Sleeve Assembly

C - EBTRON Airflow Measurement Probes

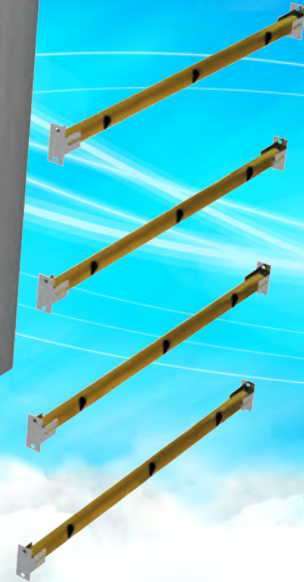

A-1

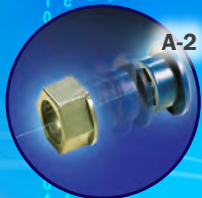

A-2

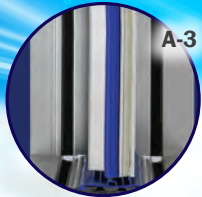

A-3

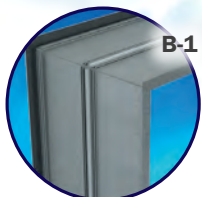

B-1

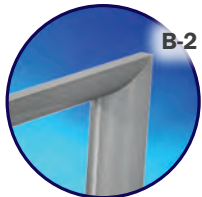

B-2

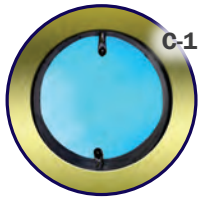

C-1



C-2

A - TAMCO Damper Assembly

- A-1 TAMCO's Slip-Proof, Maintenance-Free Linkage System
- A-2 TAMCO's Dependable Dual Bearing System
- A-3 TAMCO's Low-Leakage Blade and Frame Seals

B - TAMCO Sleeve Assembly

- B-1 TAMCO's All-Aluminum Extrusion Sleeve
- B-2 TAMCO's All-Aluminum 3" Curved Flare

C - EBTRON Airflow Measurement Probes

- C-1 Stable Bead-in-Glass Thermistors
- C-2 FEP Plenum Rated Cable with Gold Plated Connector Pins

D - EBTRON Digital Transmitter

- D-1 Microprocessor Based Transmitter with Industrial IC's
- D-2 Standard Dual Analog Output / RS-485 BACnet® Interface
- D-3 USB Data Logger Thumb Drive Interface Available
- D-4 Ethernet Interface Available
- D-5 Lon Interface Available



D - EBTRON Digital Transmitter

AIRFLOW/TEMPERATURE MEASUREMENT DEVICE FEATURES

EBTRON Thermal Dispersion Technology has been used for 27 years and is ideal for all airflow rates found in today's HVAC applications, including the direct measurement of outside air.

Precision bead-in-glass thermistors result in long-term stability and drift-free operation.

Thermistors are potted using a water-proof epoxy and can survive direct exposure to water.

Sensor probes are provided with durable, FEP jacketed, plenum rated cables, which can be exposed to UV and ultra-cold temperatures.

NIST traceable calibration standards ensure accurate measurement.

Each sensor node (up to 16 per transmitter) is computer-calibrated at 16 airflow rates, to ensure 2% of reading sensor accuracy over the entire operating range.

The standard transmitter is provided with RS-485 BTL® Listed (BACnet or Modbus) and analog outputs (dual 0-5 VDC, 0-10 VDC or 4-20mA). All protocols or output signals can be field-selected and configured.

Transmitters are also available with Ethernet (BACnet or Modbus) or Lon outputs. A unique configuration is also available to write data to a USB thumb drive.

The transmitter can be configured to set a visible and digital alarm if flow rates are outside of a user specified range.

The airflow measurement device is UL® and BTL® listed.

DAMPER & SLEEVE FEATURES

The AIR-IQ unit can be assembled with any of the following Series of TAMCO dampers: 1000 / 1500 / 1400 / 9000 / 9000 SC / 9000 BF / 9000 ECT.

Salt water resistant dampers and sleeves are also available (TAMCO Series 1000 SW / 1400 SW / 1500 SW / 9000 SW).

Aluminum construction contributes to a prolonged and rust-free operational life.

Aerodynamic, radius entry flare improves accuracy and stability in non-ducted and plenum applications.

TAMCO's engineered damper and sleeve, combined with EBTRON's high sensor density probes will not require field calibration or adjustment when installed in accordance with published guidelines.

		Number of Probes / Number of Sensors per Probe TAMCO/EBTRON AIR-IQ Package - PROBES MOUNTED PARALLEL-TO-BLADES														
		DIMENSION A WIDTH														
		12	18	24	30	36	42	48	54	60	66	72	84	96	108	120
DIMENSION B HEIGHT	12	1/2	2/2	1/4	1/4	1/4	1/4	1/6	1/6	1/6	1/6	1/6	1/6	2/4	2/4	2/4
	18	2/2	2/2	2/2	2/2	2/3	2/3	2/3	1/6	1/6	1/8	1/8	1/8	2/6	2/6	2/6
	24	4/1	2/2	2/3	2/3	2/3	2/3	2/4	2/4	2/4	2/4	2/6	2/6	2/8	2/8	2/8
	30	4/1	4/1	3/2	2/3	2/3	2/4	2/4	2/4	2/6	2/6	2/6	2/8	2/8	2/8	2/8
	36	4/1	3/2	3/2	3/2	3/3	3/3	3/4	3/4	3/4	4/4	4/4	4/4	2/8	2/8	2/8
	42	4/1	3/2	3/2	4/2	3/3	3/4	3/4	3/4	4/4	4/4	4/4	4/4	4/4	2/8	2/8
	48	3/2	3/2	4/2	4/2	4/3	4/3	4/4	4/4	4/4	4/4	4/4	4/4	4/4	4/4	4/4
	54	3/2	3/2	4/2	4/2	4/3	4/3	4/4	4/4	4/4	4/4	4/4	4/4	4/4	NA	NA
	60	3/2	3/2	4/2	4/3	4/3	4/4	4/4	4/4	4/4	4/4	4/4	4/4	4/4	NA	NA
	66	3/2	4/2	4/2	4/3	4/4	4/4	4/4	4/4	4/4	4/4	4/4	4/4	NA	NA	NA
72	3/2	4/2	4/3	4/3	4/4	4/4	4/4	4/4	4/4	4/4	4/4	NA	NA	NA	NA	

- 1 Damper Section
- 2 Damper Sections

Depending on installation accessibility requirements, probes can be provided in parallel-to or perpendicular-to damper blades mounting configurations. In addition, probes can be mounted internally within the sleeve or inserted through the side of the sleeve. This information should be provided at the time a quote is requested.

		Number of Probes / Number of Sensors per Probe TAMCO/EBTRON AIR-IQ Package - PROBES MOUNTED PERPENDICULAR-TO-BLADES														
		DIMENSION A WIDTH														
		12	18	24	30	36	42	48	54	60	66	72	84	96	108	120
DIMENSION B HEIGHT	12	1/2	2/2	4/1	4/1	4/1	4/1	3/2	3/2	3/2	4/2	4/2	4/2	4/2	4/2	4/2
	18	2/2	2/2	2/2	2/2	3/2	3/2	3/2	3/2	3/2	4/2	4/2	4/2	4/3	4/3	4/3
	24	1/4	2/2	3/2	3/2	3/2	3/2	4/2	4/2	4/2	4/2	4/3	4/3	4/4	4/4	4/4
	30	1/4	1/4	2/3	3/2	3/2	4/2	4/2	4/2	4/3	4/3	4/3	4/4	4/4	4/4	4/4
	36	1/4	2/3	2/3	2/3	3/3	3/3	4/3	4/3	4/3	4/4	4/4	4/4	4/4	4/4	4/4
	42	1/4	2/3	2/3	2/4	3/3	4/3	4/3	4/3	4/4	4/4	4/4	4/4	4/4	4/4	4/4
	48	2/3	2/3	2/4	2/4	3/4	3/4	4/4	4/4	4/4	4/4	4/4	4/4	4/4	4/4	4/4
	54	2/3	2/3	2/4	2/4	3/4	3/4	4/4	4/4	4/4	4/4	4/4	4/4	4/4	NA	NA
	60	2/3	2/3	2/4	3/4	3/4	4/4	4/4	4/4	4/4	4/4	4/4	4/4	4/4	NA	NA
	66	2/3	2/4	2/4	3/4	4/4	4/4	4/4	4/4	4/4	4/4	4/4	4/4	4/4	NA	NA
72	2/3	2/4	3/4	3/4	4/4	4/4	4/4	4/4	4/4	4/4	4/4	NA	NA	NA	NA	

- 1 Damper Section
- 2 Damper Sections

AIR-IQ GENERAL MECHANICAL OVERVIEW

Typical single and two-section horizontal dampers are illustrated below. Vertical damper blade configurations are also available. For series-specific damper options and details, refer to the individual series specifications and data sheets available at www.tamcodampers.com. Complete EBTRON Gold Series GTX.116 Air Flow Transmitter options and details are available at www.EBTRON.com.

AIR-IQ TYPICAL SINGLE SECTION HORIZONTAL BLADE DAMPER

FLANGED-TO-DUCT MOUNT TYPE

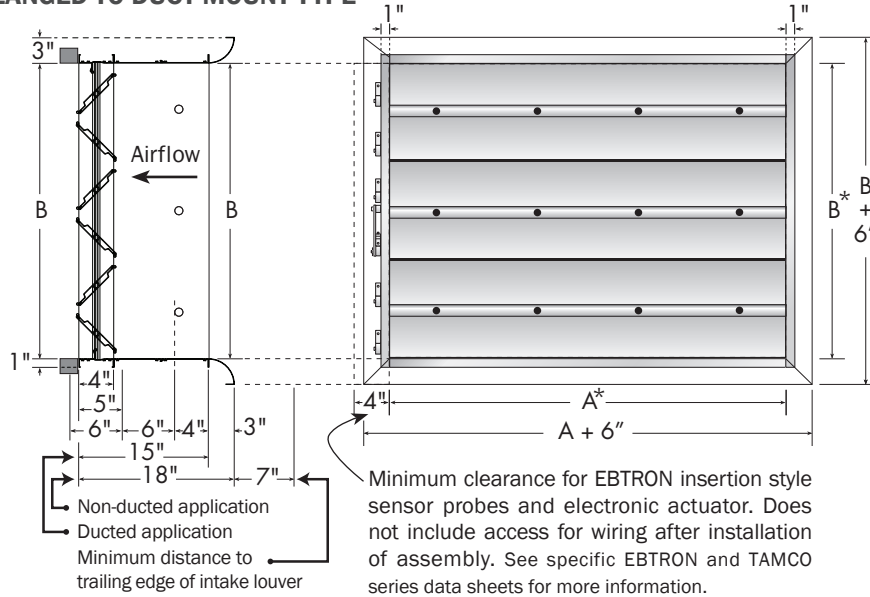

FLANGED-TO-DUCT MOUNT TYPE

Minimum Size:

Damper: 6" w x 6" h

Maximum Size:

60" w x 60" h or
48" w x 72" h

(Limiting section width to 48" allows height to increase to 72".)

Maximum Area:

25 ft.²

***NOTES:**

A x B: = Always opening dimensions

Width = A: Always dimension parallel to blades

Height = B: Always dimension perpendicular to blades

INSTALLED-IN-DUCT MOUNT TYPE

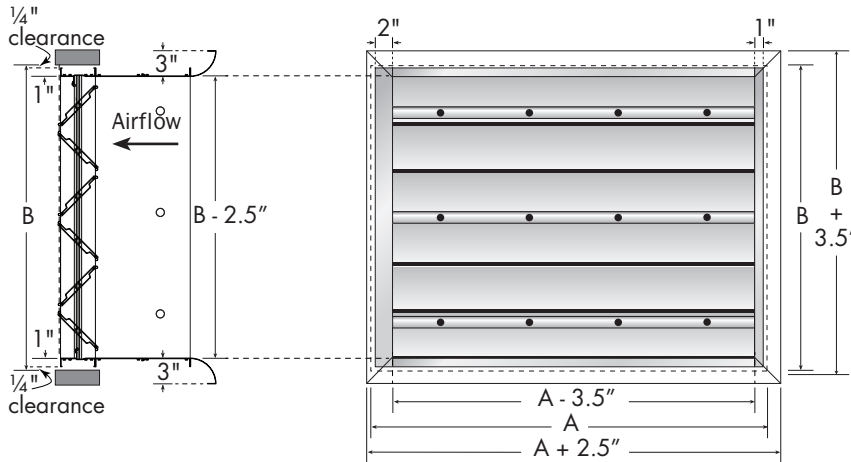

INSTALLED-IN-DUCT MOUNT TYPE

Minimum Size:

Damper: 9.5" w x 8.5" h

Maximum Size:

60" w x 60" h or
48" w x 72" h

(Limiting section width to 48" allows height to increase to 72".)

Maximum Area:

25 ft.²

AIR-IQ TYPICAL TWO-SECTION HORIZONTAL BLADE DAMPER

INSTALLED-IN-DUCT AND FLANGED-TO-DUCT MOUNT TYPES

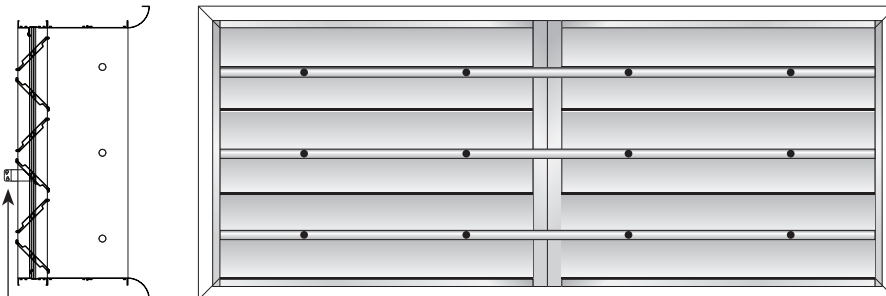

Jumpers will always be on the face of damper, downstream from the louver

TWO-SECTION

INSTALLED-IN-DUCT AND FLANGED-TO-DUCT MOUNT TYPES

Minimum Size:

Flanged-to-duct damper:
60" w x 6" h

Installed-in-duct damper:
60" w x 8.5" h

Maximum Size:

For maximum sizes, see table titled:
AIR-IQ AVAILABLE SIZES / SENSOR PROBE SUITE CONFIGURATION

Maximum Area:

40 ft.²

Contact TAMCO Customer Service for information regarding sleeve sizes and finished outside flare dimensions for two-section assemblies.

ENGINEER'S GUIDE SPECIFICATION

CONTROL DAMPER WITH INTEGRAL AIRFLOW MEASURING DEVICE

Provide an integral airflow/temperature measurement control damper package. Package shall not require any additional duct work or sleeve, when installed in accordance with manufacturer's specified placement guidelines.

Manufacturer and Model:

- TAMCO/EBTRON Series [insert appropriate TAMCO damper series] AIR-IQ

Damper and Sleeve Assembly:

- Provide one or more damper sections for each location indicated on the plans. Damper section(s) shall be integral to sleeve assembly.
- Provide a factory-assembled, extruded aluminum (6063T5) sleeve, not less than .080" thick for each damper section. Sleeve depth, including damper frame, shall be 15" for ducted applications and 18" for non-ducted applications. Non-ducted applications shall include a 3" radius aluminum entry flare. Provide an additional 7" (10" for ducted applications) between the downstream edge of an intake louver and the leading edge of the sleeve for outside air intake applications that are close-coupled to intake louvers.
- Provide extruded aluminum (6063T5) damper frames, not less than .080" thick and 4" deep.
- Provide extruded aluminum (6063T5) damper blade profiles. Blade seals shall be extruded EPDM or silicone (dependant upon damper Series selected). Frame seals shall be extruded silicone. Seals shall be secured in an integral slot within the aluminum extrusions.
- Bearings shall be composed of a Celcon inner bearing fixed to a 7/16" aluminum hexagon blade pin, rotating within a polycarbonate outer bearing inserted in the frame, resulting in no metal-to-metal or metal-to-plastic contact.
- Linkage hardware shall be installed in the frame side and constructed of aluminum and corrosion resistant, zinc-plated steel, complete with cup-point trunnion screws for a slip-proof grip.
- Damper air leakage shall not exceed 3 cfm/ft² against 1" w.g. differential static pressure.
- Dampers shall be available with either opposed blade action or parallel blade action and made to size without blanking off free area.
- Dampers shall be designed for operation in temperatures ranging between -72° F and 212° F.
- (For Thermally Insulated or Salt Water Resistance Dampers refer to additional information listing below.)

Integral airflow measuring device:

- Provide one thermal dispersion airflow/temperature measuring device (ATMD) for each location. Differential pressure based devices, including pitot tubes and arrays, are not acceptable.
- Each ATMD shall consist of one or more factory-mounted, multi-point, measuring probes and microprocessor-based transmitter (remotely mounted by others).
- Each sensor probe shall consist of one to eight independent sensor nodes in a gold anodized, extruded aluminum (6063T5) tube with aluminum mounting brackets.
- Each sensor node shall consist of two hermetically sealed bead-in-glass thermistors. Chip thermistors of any type or packaging are not acceptable.
- Thermistors shall be potted in an engineered thermoplastic assembly using water-proof, marine epoxy and shall not be damaged by moisture or direct contact with water.
- Signal processing circuitry on or in the sensor probe is not acceptable.
- Each sensing node shall be individually wind tunnel calibrated at 16 points to NIST traceable airflow standards.
- All internal wiring between thermistors and probe connecting cables shall be Kynar[®] jacketed.
- Manufacturer shall provide UL listed, FEP jacketed, plenum rated cable(s) between sensor probes and the remote transmitter.
- Each sensing node shall have a temperature accuracy of +/- 0.14° F
- Each sensing node shall have a calibrated airflow accuracy of +/- 2% of reading and the overall installed accuracy of the assembly shall be better than +/- 5% of reading at any damper position.
- The ATMD shall be capable of measuring airflow rates over the full range of 0 to 5,000 FPM between -20° F and 160° F.
- The transmitter shall be powered by 24 VAC, be over-voltage and over-current protected, and have a watchdog circuit to provide continuous operation after power failures and/or brown-outs.
- The power requirement for the ATMD shall not exceed 22 V-A.
- The transmitter shall determine the airflow rate and temperature of each sensing node prior to averaging.
- The transmitter shall have two isolated and fused analog output signals and one RS-485 network connection.
- Each analog output shall be field configurable as linear 0-5 VDC, 0-10 VDC or 4-20mA signals.
- One analog output signal shall provide the average airflow rate.
- One analog output signal shall be field configurable to output the average temperature, the velocity weighted temperature or a binary airflow alarm.
- The RS-485 network connection shall be field configurable as BACnet MS/TP or Modbus RTU.
- The RS-485 connections shall be capable of transmitting the average airflow rate, average temperature, individual airflow rates of each sensor node, and individual temperatures of each sensor node and system status.
- All integrated circuits shall be industrial rated
- All electrical plugs, receptacles and circuit board interconnects shall be gold-plated.
- The ATMD shall be UL 973 listed.
- The ATMD shall be BTL listed.

FOR MORE INFORMATION

For additional information regarding TAMCO dampers, refer to:

- Series 1000, 1400, 1500, 9000, 9000 SC, 9000 BF, 9000 ECT, 1000 SW, 1400 SW, 1500 SW, 9000 SW Specification Sheets
- Series 1500, 1500 SW, 1000 & 1000 SW Pressure Drop Charts
- Series 9000 BF, 9000 ECT, 9000 SC & 9000 SW Pressure Drop Charts
- Series 1500, 1500 SW, 1000 & 1000 SW Free Area Charts
- Series 9000 BF, 9000 ECT, 9000 SC & 9000 SW Free Area Charts
- Series 1400 – 4" Wide Air-Foil Blade Control Damper Free Area Charts

For additional information regarding EBTRON airflow measuring devices, refer to:

- TS_GTC116PC.pdf
- TS_GTN116PC.pdf
- TS_GTE116PC.pdf
- TS_GTL116PC.pdf
- TM_GP1.pdf
- TM_GTx116.pdf